

# The Power Controller for System Solutions in the Production and Process Industries



Product Brief · January 2005

# simatic S7-400



**SIEMENS**

# What advantages are offered by the powerful S7-400?

Machine and plant constructors have been experiencing excessive competitive pressure for many years already, and are attempting to retain or expand the profit situation by reducing times and saving costs. Although sales prices are being reduced in certain cases, they are still expected to offer machines which are more powerful and productive, thus placing new demands on the implemented automation systems. Modular automation systems are expected with a large scope of functions and high performance at favorable prices. The networking facilities should be improved at the same time, but the engineering requirements should be reduced.

Numerous users therefore trust Totally Integrated Automation with its many successful reference applications worldwide from many different industrial sectors. They therefore profit from the experience, the global servicing facilities and the quality of SIMATIC systems and products.

This is the basis for increasing profits and improving competitiveness using innovative automation solutions.

Within the range of PLCs, the SIMATIC S7-400 has been designed for system solutions in production and process automation.

## Reduction of engineering costs

In conjunction with the SIMATIC Engineering Tools, the S7-400 results in extremely efficient configuring and programming, particularly in extensive automation solutions with a high proportion of engineering. Examples include high-level languages like S7-SCL as well as and graphical Engineering Tools for sequential controls (S7-GRAPH), state diagrams (S7-HiGraph) and technology-oriented diagrams (CFC).

## Reduction of operating costs

Saving of the complete project data including symbols and comments on the CPU facilitates and simplifies servicing and maintenance.

In addition, powerful integrated system diagnostics functions guarantee increased availability of the controller and therefore greater productivity. To this are added configurable process diagnostics functions for analysis of process faults in order to reduce downtimes and further boost productivity.

## Increase in machine cycle rates

The significantly innovated CPUs set new standards with respect to processing speed and communications performance. As a result of the significantly improved performance, the new CPUs provide the basis for shorter machine cycle times and therefore higher productivity.

## New functions

The reserve capacity of the innovated CPUs means that it is possible to integrate new functions without further hardware investments, e.g. processing of quality data, convenient diagnostics, integration into host MES solutions, or fast communications via bus systems.

## Highlights

The following features make the S7-400 into the most powerful PLC:

- The S7-400 is particularly suitable for data-intensive tasks in the process industry; high processing speeds and deterministic response times ensure short machine cycle times for fast machines in the production industry.
- The S7-400 is preferably used to coordinate complete plants and to control lower-level communication lines with slave stations; this is ensured by the high communications performance and integral interfaces.
- The S7-400 has a scalable performance thanks to the graded range of CPUs; the capacity for I/Os is almost unlimited.
- Safety engineering and standard automation can be integrated in one S7-400 PLC; the plant availability can be increased by using a redundant S7-400 design.
- The S7-400 can be set up in a modular configuration without having to observe slot rules; a versatile range of modules is available both for the central configuration and for distributed structures.
- The S7-400 is efficiently configured and programmed using STEP 7, the global standard; SIMATIC engineering tools are used to reduce costs even further; powerful, integral diagnostics functions increase the S7-400 availability.
- Expansions to the S7-400 can be carried out extremely flexibly during operation; hot swapping of modules is possible.

# Versatile application possibilities

## Areas of application

Application areas are found in

- the automobile industry
- mechanical engineering, including specialist machine construction
- warehousing
- building systems automation
- the steel industry
- energy generation and energy distribution
- the paper and printing industry
- woodworking
- textile manufacture
- pharmaceuticals
- the food and beverages industry
- process engineering, e.g. water supply and disposal
- the chemical and petrochemical industries



*Application in a brewery ...*

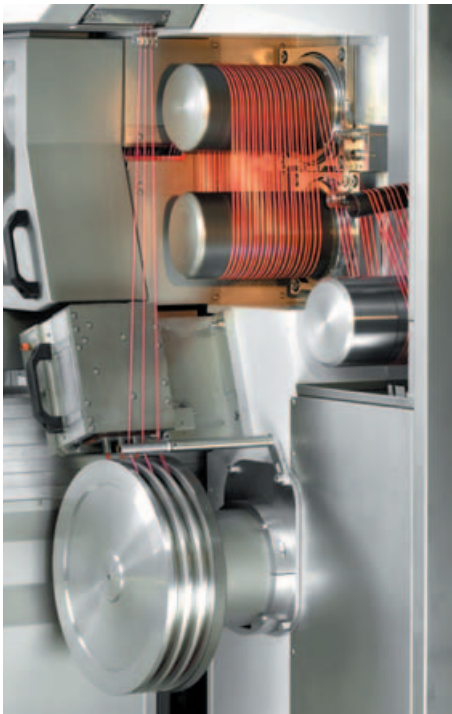

*... or in the textile industry*

## Special applications

There are other versions of the S7-400 available for specialist applications:

- *Applications requiring fault tolerance* can be implemented with the S7-400H,
- For *fail-safe applications* there is the S7-400F that is also available in a fault-tolerant version (S7-400FH),
- S7-400 CPUs are available as PC plug-in cards for *PC-based solutions* (WinAC Slot).

# Design, modularity, expansion

## Design

An S7-400 system consists basically of a backplane, a power supply, and a CPU. A modular design is possible and permits expansion. All other modules can be positioned as desired next to the power supply located on the left. The S7-400 is characterized by rugged fan-free operation with hot swapping of signal modules.

A diverse range of modules can be used both for centralized expansions and for easy setup of distributed structures with the ET 200; this results in extremely low-cost spare parts inventory.



In addition to the standard racks, two aluminum racks are available with 9 and 18 slots. These aluminum racks have a higher resistance to unfavorable ambient conditions, are more distortion-resistant, and approx. 25% lighter.



Easy assembly of S7-400 by hooking module into backplane

## Modularity

Modularity is an important feature of the S7-400. The powerful backplane bus of the S7-400, and the communications interfaces that can be connected direct to the CPU, allow high-performance operation of a large number of communications lines.

This makes it possible, for example, to break up the system into a line for HMI and programming tasks, one for high-performance and equidistant motion control components, and one for the "normal" I/O field bus. Additionally required connections to MES/ERP systems or to the Internet can also be implemented.

Central or distributed expansion of the S7-400 is possible depending on the task. Central expansion is carried out using expansion units. PROFIBUS is used for the distributed expansion; using a CP, expansion is also possible with Ethernet/PROFINET.

## Expansion

### Central expansion

In the case of central expansion, further racks are linked directly to the central controller. A distance of up to 100 m is possible; the full performance of the backplane bus is nevertheless available. The power supply can also be looped through for shorter distances.

Racks with 4, 9 or 18 slots are available as the central controller. Via interface modules, up to 21 expansion units can be connected, each containing 18 or 9 slots for S7-400 modules.

### Distributed expansion

PROFIBUS is used for distributed expansion. The connection to the PROFIBUS world is provided by the S7-400 via the PROFIBUS DP interface integrated on the CPU. Thus a wide range of I/O modules is available with different degrees of protection (e.g. IP20, IP65/67) with which the S7-400 can be adapted to highly versatile tasks. PROFINET opens up the world of Industrial Ethernet for the S7-400, e.g. for connection of distributed field devices (see page 16).

# Graded range of CPUs

There is a graded range of CPUs available for controller design, from the entry-level CPU right up to the high-performance CPU.

All CPUs have large quantity structures, and several CPUs can work together in multicomputing configurations in order to boost performance. The CPUs enable short machine cycle times, thanks to their efficient processing speed and deterministic response times.

The CPUs differ, e.g. in RAM, address range, number of connections and processing time.

## Multi-computing

Multi-computing, i.e. running more than one CPU in a S7-400 central controller, has a number of benefits to the user:

- Multi-computing means that the overall performance of an S7-400 can be split up. For example, complex technical functions, such as controlling, computing or communicating, can be separated and assigned to different CPUs. For this purpose, each CPU can be assigned its own, local I/O.
- Multi-computing also enables different functions to be separated from one another, so, for example, one CPU can process the time-critical processing functions and another CPU the non-time critical functions.

In multi-computing mode, all the CPUs together act as a single CPU, i.e. if one CPU goes into STOP mode, all the other CPUs stop at the same time. Synchronization calls enable the actions of multiple CPUs to be coordinated for each individual instruction.

At the same time, data transfer between the CPUs is extremely fast thanks to the "Global Data" mechanism.

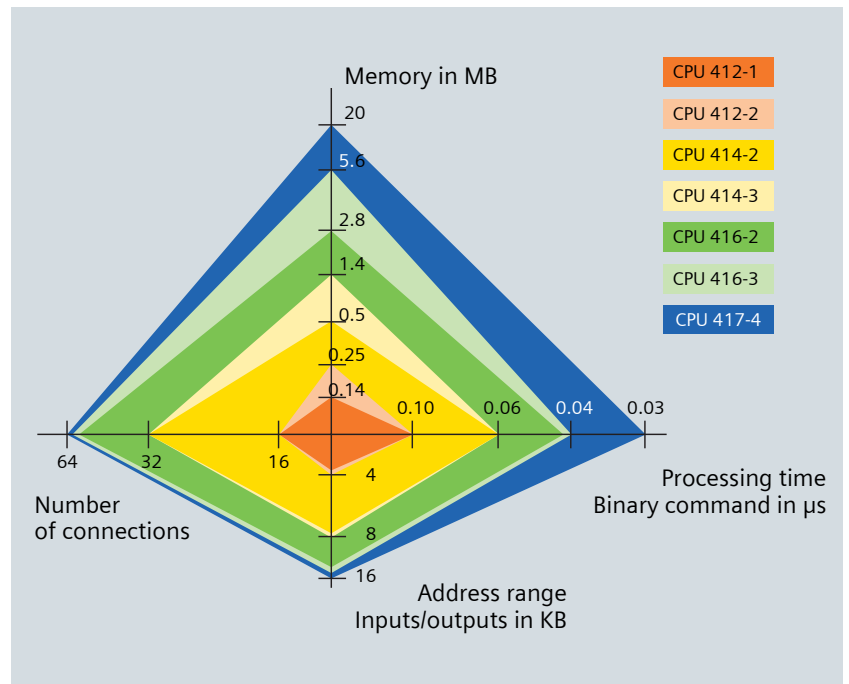

Seven CPUs of graded performance for the S7-400

## Performance

The S7-400 stands out not only for its short response times, but also for its large performance reserves. Very short response times can be attained, even when simultaneous communication is required, or other unforeseeable loads occur. This, in turn, makes it possible to obtain specific response times, e.g. the response of an output signal to a change in input signal.

Furthermore, additional functions can be integrated into the CPUs without further hardware investments. Examples of new functions include the saving and processing of quality data, user-friendly diagnostics, or vertical integration into host MES solutions. The improved communications performance permits fast communication via Ethernet as well as efficient integration of the field level via PROFIBUS, e.g. with tasks in isochrone mode.

## Diagnostics

The CPUs' intelligent diagnostics system continuously monitors the functionality of the system and the process, and registers errors and specific system events (CPU black-box); there is also the option of adding extra diagnostic messages.

The diagnostics function can determine whether the signal logging (for digital modules) or analog processing (analog modules) functions of the module are in good working order. In the event of a diagnostics message (e.g. "no supply to encoder"), the module triggers a diagnostics interrupt.

The CPU then interrupts the processing of the user program and executes the appropriate diagnostics interrupt block.

Process interrupts mean that process signals can be monitored and reactions to signal changes can be triggered.

# CPU innovation – increase in performance

The S7-400 CPUs are being innovated and will receive significantly more powerful processors and will convince with their maximum possible dynamic performance. In addition to a larger quantity breakdown (more RAM, uniformly high quantity of timers and counters), they will particularly feature a significantly increased performance. This will be evident in significantly higher processing speeds.

The increased features permit the integration of additional functions or an increase in machine cycle rates without further hardware investments. Examples of new functions include the saving and processing of quality data, convenient diagnostics, or the vertical integration into host MES solutions. The improved communications performance permits fast Ethernet communication as well as efficient interfacing of the field level using PROFIBUS, e.g. for isochronous functions.

## Increase in processing speed

The most evident feature of the new CPUs is the significant increase in processing speed. With bit commands, the execution times are approximately halved. With more complex commands, the increase in speed is between factors of 13 and 70! Since the execution times of the complex commands could be reduced over-proportionally, the bandwidth of all command execution times has become significantly smaller. Thus these complex commands have a far smaller influence on the total execution time of the user program, and the processing of programs with many arithmetic functions is accelerated accordingly.

## Further properties

The new CPUs are compatible with the previous ones with respect to spare parts and programs, i.e. a previous CPU can be replaced by a new one without problem, without negative effects, and without having to change the program.

The previous memory cards can also be used further.

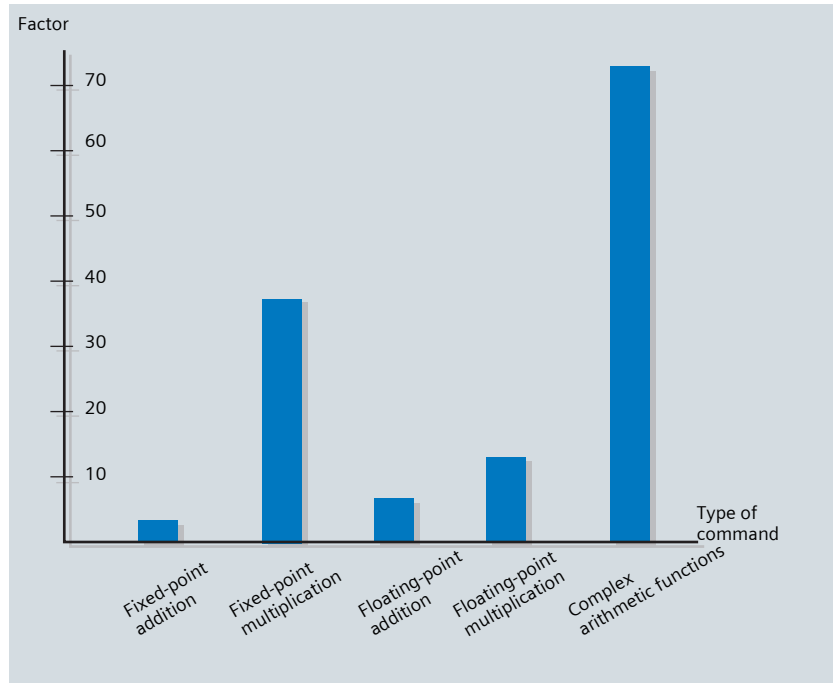

Increase in processing speeds of the CPU 417-4 compared to the previous version

Innovative interface modules are also available to configure further DP lines for the CPUs 414-3, 416-3 and 417-4.

Furthermore, the new S7-400 CPUs can also replace the CPU 945 of the SIMATIC S5 with respect to processing speed.

Further features of the new CPUs include:

- As with the S7-300-CPU, the S7-400-CPU will also be provided with a toggle switch in the future.
- Only one row of LEDs is required to display the CPU status (except for the fault-tolerant CPUs).

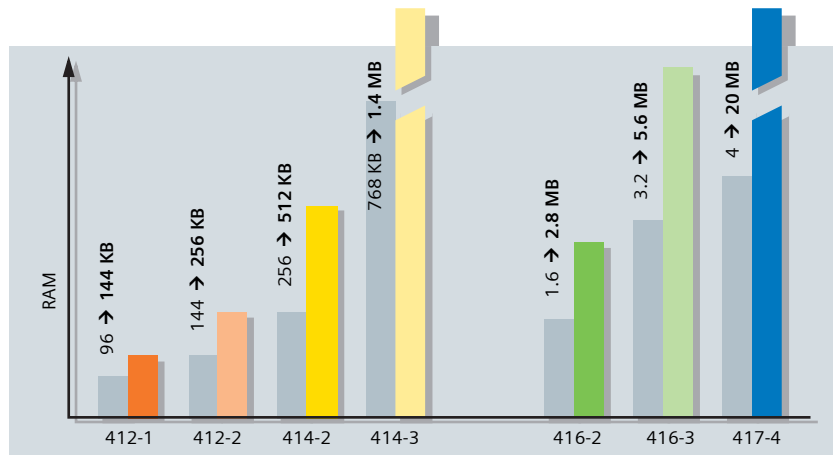

Increase in RAM of new CPUs compared to previous version

# Memory concept, backup

## Data/program memories

All S7-400 CPUs have separate memories for data and program. This division of the main memory results in an increase in performance by 100% for certain constellations. While a standard processor accesses its RAM at least twice, the special S7-400 processor accesses the code memory and the data memory simultaneously in a single cycle. This is made possible by the separate code and data bus. This is direct performance which is of benefit to the customer!

The size of the main memory is determined by selecting the appropriate CPU from the finely graded range of CPUs.

The integrated memory (RAM) is adequate for small to medium-sized programs. For larger programs, the memory can be increased by slotting in extra RAM or FEPRAM cards.

**NEW** With the new 64 MB RAM card it is possible to even save the contents of the complete main memory of the largest CPU. This RAM is buffered by a battery of the power supply. RAM cards are used in particular if it is e.g. necessary to frequently change the user program during the commissioning phase. RAM cards permit faster saving than FEPRAM cards, and can be overwritten any number of times.

To enable retentive memory without the use of a backup battery, additional FEPRAM cards are available whose data are not lost even when the card is removed.

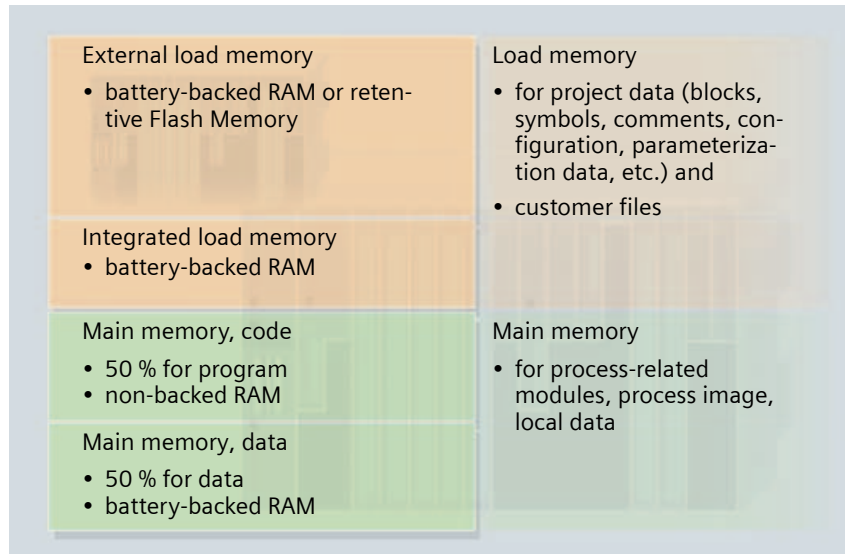

Memory types for the SIMATIC S7-400

## Backup battery

The power supply modules of the S7-400 have a battery compartment to accommodate one or two backup batteries. In the event of a power supply failure, this battery buffers the set parameters and the memory contents (RAM) in CPUs and parameterizable modules via the backplane bus.

Furthermore, the backup battery permits restarting of the CPU following a power failure. Both the power supply module and the buffered modules monitor the battery voltage, and indicate when the battery is discharged.

# CPUs – Technical specifications

	CPU 412-1	CPU 412-2	CPU 414-2	CPU 414-3
<b>Main memory</b>				
• integrated	144 KB	256 KB	512 KB	1.4 MB
• in instructions	24 K	42 K	84 K	230 K
• for program	72 KB	128 KB	256 KB	700 KB
• for data	72 KB	128 KB	256 KB	700 KB
<b>Load memory</b>				
• integrated	256 KB RAM			
• expandable to	64 MB			
• Backup	✓			
<b>Number of blocks</b>				
• FB	256		2048	
• FC	256		2048	
• DB	511 (DB 0 reserved)		4095 (DB 0 reserved)	
<b>Program execution</b>				
• free cycle	1		1	
• timed interrupts	2		4	
• delay interrupts	2		4	
• time interrupts	2		4	
• process interrupts	2		4	
• multi-computing interrupt	1		1	
• startup	3		3	
<b>Execution times</b>				
• bit operations	0.1 µs		0.06 µs	
• word operations	0.1 µs		0.06 µs	
• fixed point arithmetic	0.1 µs		0.06 µs	
• floating point arithmetic	0.3 µs		0.18 µs	
<b>Bit memories/timers/counter</b>				
• Bit memories	4 KB		8 KB	
• S7 timers/S7 counters	2048/2048		2048/2048	
• IEC timers/IEC counters	SFB/SFB		SFB/SFB	
<b>Design</b>				
• Number of expansion units	21			
• Num. of DP masters, through CP	max. 10			
• Number of FMs	limited by number of slots and number of connections			
• Number of CPs	limited by number of slots and number of connections			
<b>MPI/DP interface</b>				
• Number of DP slaves	32		32	
• Transmission speed	max. 12 Mbit/s		max. 12 Mbit/s	
<b>DP interfaces</b>				
• Number	–	1	1	2
• Number of DP slaves	–	64	96	96 each
• Transmission speed	–	max. 12 Mbit/s	max. 12 Mbit/s	max. 12 Mbit/s
• Interface modules for insertion	–	–	–	1 x DP
<b>Address ranges</b>				
• Total I/O address area	4 KB/4 KB		8 KB/8 KB	
• I/O process image	4 KB/4 KB		8 KB/8 KB	
• Total digital channels	32768/32768		65536/65536	
• Total analog channels	2048/2048		4096/4096	
<b>MLFB group</b>	6ES7412-1XF...	6ES7412-2XG...	6ES7414-2XG...	6ES7414-3XJ...

	CPU 416-2	CPU 416-3	CPU 417-4
<b>Main memory</b>			
• integrated	2.8 MB	5.6 MB	20 MB
• in instructions	460 K	930 K	3.3 M
• for program	1.4 MB	2.8 MB	10 MB
• for data	1.4 MB	2.8 MB	10 MB
<b>Load memory</b>			
• integrated	256 KB RAM		
• expandable to	64 MB		
Backup	✓		
<b>Number of blocks</b>			
• FB	2048		6144
• FC	2048		6144
• DB	4095 (DB 0 reserved)		8191 (DB 0 reserved)
<b>Program execution</b>			
• free cycle	1		1
• timed interrupts	8		8
• delay interrupts	4		4
• time interrupts	9		9
• process interrupts	8		8
• multi-computing interrupt	1		1
• startup	3		3
<b>Execution times</b>			
• bit operations	0.04 µs		0.03 µs
• word operations	0.04 µs		0.03 µs
• fixed point arithmetic	0.04 µs		0.03 µs
• floating point arithmetic	0.12 µs		0.09 µs
<b>Bit memories/timers/counter</b>			
• Bit memories	16 KB		
• S7 timers/S7 counters	2048/2048		
• IEC timers/IEC counters	SFB/SFB		
<b>Design</b>			
• Number of expansion units	21		
• Num. of DP masters, through CP	max. 10		
• Number of FMs	limited by number of slots and number of connections		
• Number of CPs	limited by number of slots and number of connections		
<b>MPI/DP interface</b>			
• Number of DP slaves	32		
• Transmission speed	max. 12 Mbit/s		
<b>DP interfaces</b>			
• Number	1	2	3
• Number of DP slaves	125	125 each	125 each
• Transmission speed	max. 12 Mbit/s	max. 12 Mbit/s	max. 12 Mbit/s
• Interface modules for insertion	–	1 x DP	2 x DP
<b>Address ranges</b>			
• Total I/O address area	16 KB/16 KB		
• I/O process image	16 KB/16 KB		
• Total digital channels	131072/131072		
• Total analog channels	8192/8192		
<b>MLFB group</b>	6ES7416-2XK...	6ES7416-3XL...	6ES7417-4XL...

# Isochrone mode for fast and exact processing

The S7-400 is now capable of providing distributed I/O solutions with the capability to handle extremely fast processes with very high precision.

Applications associated with such demands are e.g.

- Motion control
- Synchronism
- Closed-loop controls
- Software-based cam controls
- Measurements at several points
- Speed and flow measurements

Consequently, production can be enhanced while at the same time increasing quality. This was made possible by the new system function denoted "isochrone mode" (not with fault-tolerant CPUs).

This is understood to be the synchronous coupling of signal acquisition and output by the distributed I/O signal transmission via PROFIBUS, and program processing at the clock rate of the equidistant PROFIBUS. This results in a system which records its input signals, processes them, and passes on the output signals at constant intervals. The S7-400 thus guarantees exactly reproducible and defined process response times as well as equidistant and synchronous signal processing for the distributed I/O.

Exact repeatability of all timing sequences means that even fast processes can be handled reliably. A comprehensive range of components is available which supports isochrone mode in order to solve many applications from the motion control, measurement or control sectors.

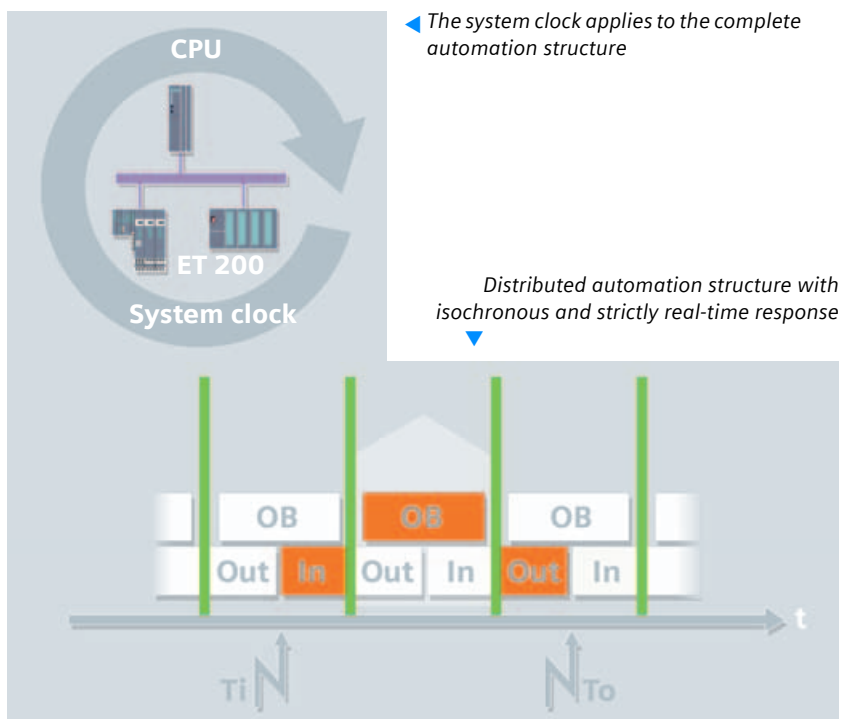

- The user program is *synchronized* with the I/O processing. Synchronism means that all process timings are matched to one another, and that all input data are recorded at a defined point in time. In the same manner, the output data become effective at a defined point in time. The input and output data are synchronized according to the system clock up to the terminal. The data of one cycle are always processed in the next cycle.
- The input and output data are processed *equidistant*. Equidistance means that input data are always read in at the same intervals, and output data are always output at the same intervals.
- All input and output data are transmitted *consistently*. Consistence means that all data of the process image belong together logically and with respect to time.

Features	Application
Recording of actual values and output of setpoints are carried out in synchronism, i.e. simultaneously for all inputs and all outputs, in order to generate consistent process images.	<ul style="list-style-type: none"> <li>• Synchronous applications are more exact since the respective positions are measured simultaneously.</li> <li>• Signals which are close in time can also be spatially distributed using distributed I/Os, e.g. start signals to several units where the time sequence is relevant.</li> <li>• As a result of recording at the same time and synchronous transmission, the I/O image is consistent. This allows e.g. the generation of a ratio of several analog values (e.g. several pressure values in a press).</li> </ul>
Recording of actual values and output of setpoints are carried out equidistantly, i.e. always at the same intervals	<ul style="list-style-type: none"> <li>• Calculations from the difference between actual values, e.g. during speed or flow measurements.</li> <li>• Dosing procedures.</li> <li>• Control loops can also be connected via distributed I/Os.</li> </ul>

# Changes in configuration in RUN mode

Modifications or expansions of a (partial) plant are also required while in run mode, e.g. to implement new sensors or actuators, or to change the parameters of I/O modules (e.g. selection of other interrupt limits).

Such applications are encountered with non-stop requirements, i.e. with continuous processes which cannot be switched off or where the production should not be interrupted: process or production plants with high restart costs.

SIMATIC S7-400 now allows hardware reconfigurations without any adverse effects while in run mode. CiR (Configuration in RUN) allows commissioning and retrofitting while the plant is in full operation.

## Advantages

- CiR allows plant expansion and optimization. The expansion or conversion of a plant can be carried out without interrupting process operation. These modifications are carried out reaction-free. Expansions and conversions can therefore be carried out cheaper and faster.

- Modifications in run mode also permit a highly flexible response to process changes and process optimizations.
- In addition, the time required for the conversion of plants which are not subject to non-stop requirements can also be shortened through modification and reconfiguration in run mode, since the plant must not be re-initialized and synchronized when hardware is changed.

## Application

Modifications to the hardware configuration in run mode are possible with distributed I/Os. All standard CPUs of the S7-400 can be used, as well as the fault-tolerant S7-400H CPUs in non-redundant mode.

CiR procedures can be carried out with the following DP masters:

- CPU via integral interfaces
- CP 443-5 ext (V5.0 and higher)
- IF 964-DP interface module

S7-400H CPUs with a redundant configuration can be modified in run mode using the H-CiR function.

## Functions

The following changes to the hardware configuration of a plant can be carried out in run mode:

- Addition of distributed I/O stations (PROFIBUS DP and PROFIBUS PA slaves), e.g. for designing a further process line
- Addition of I/O modules in the ET 200M I/O system, e.g. to implement additional sensor systems
- Reversal of modifications, i.e. added field devices (DP/PA slaves) and modules can be removed again
- Modification of I/O module parameters in the ET 200M I/O system, e.g. in the case of a spare part when using a sensor with different specifications, or for selecting other interrupt limits

*Range of modules which can be added to or removed from a plant with an S7-400 as master ▼*

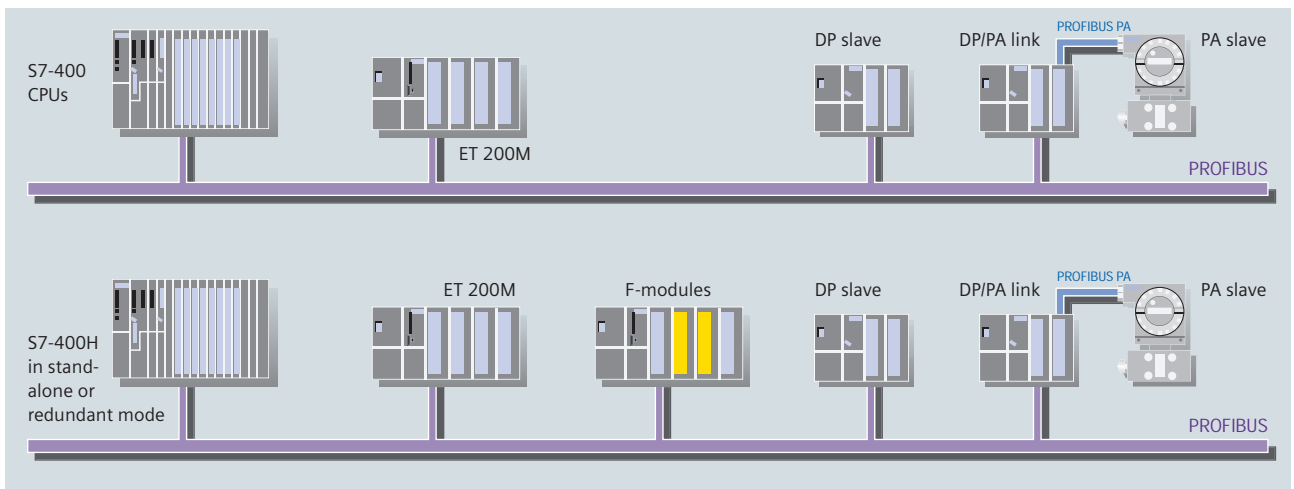

# Fault-tolerant S7-400H PLC

As a result of the increasing degree of automation of industrial plants, the availability of the used systems is becoming increasingly important. Failures or faults in automation systems result in non-productive and expensive downtimes on the one hand, and in high restart costs on the other. Furthermore, increasing cost pressure result in the desire to operate machines and plants with as few personnel as possible.

## Switchover time

As a result of their redundant structure, fault-tolerant automation systems can continue the production process even following a fault. Switching over from the master system to the backup system is carried out within the so-called switchover time. Depending on the duration of this switchover time, a differentiation is made between warm standby (longer switchover time) and hot standby (short switchover time). Downtimes and restart costs can thus be significantly reduced.

## Configuration

In the fault-free state, the master controller (station A) controls the fault-tolerant area. The backup controller (station B) also has access to this fault-tolerant area. If the master fails, the backup controller takes over control of the fault-tolerant area. The fault-tolerant area is therefore also available in the event of a fault.

Both controllers can additionally control normal I/Os without increased availability requirements, i.e. a PLC can handle both the normal area and the fault-tolerant area.

The SIMATIC S7-400H is a PLC with two fault-tolerant CPUs of the same type, where a switch is made from the master system to the backup station in the event of a fault. It is suitable for fault-tolerant processes with hot standby requirements (processes with switchover times shorter than 100 ms).

## Synchronization

The method of event-controlled synchronization permits fast, bumpless switchover to the redundant CPU in the event of a fault. This CPU then continues processing from the point of interruption without loss of information or interrupts. The operating system guarantees that all commands whose execution would result in different statuses in the two systems are executed in synchronism. This is achieved without the user having to carry out any programming or parameter settings.



▲ Fault-tolerant SIMATIC S7-400H

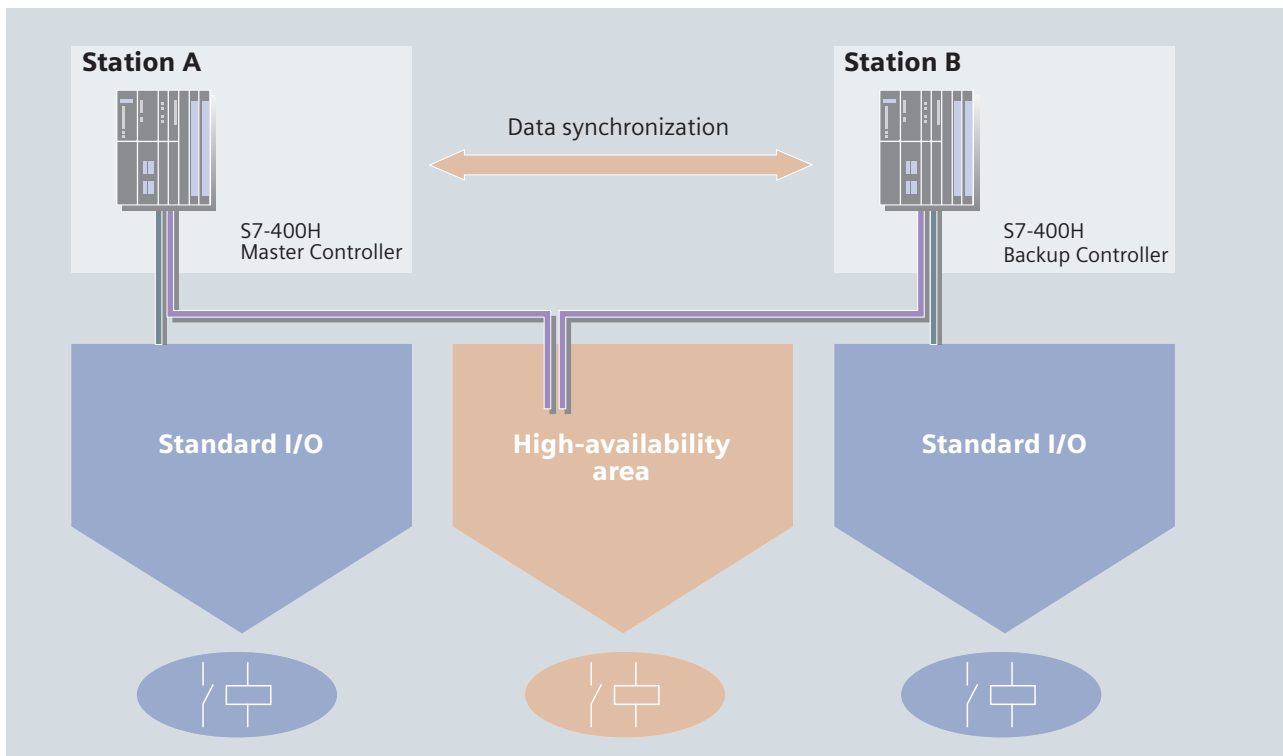

# Fail-safe S7-400F/FH PLC

SIMATIC Safety Integrated comprises the fail-safe SIMATIC PLCs as well as I/Os and engineering within the product range of Safety Integrated. When a fault occurs, the application can be transferred as required to a safe state or held in an existing safe state. These fail-safe PLCs are based on the proven standard PLCs.

The PROFIBUS has been expanded by the PROFIsafe profile for safety-relevant communications.



Fail-safe and fault-tolerant SIMATIC S7-400F/FH

Thus safety-relevant and standard communication are possible over just one standard PROFIBUS cable.

The engineering for the standard and safety functions of these fail-safe SIMATIC PLCs is carried out using the same configuration tools (STEP® 7). In a SIMATIC PLC, the safety technology is thus integrated seamlessly into the standard automation.

As a result of the fine-modular design of the fail-safe I/O, safety technology need only be used where it is actually required. A combined design with safety and standard components is easy - as is the coexistence of safety-relevant and standard programs in one PLC.

## Production automation

The CPU 416F of the S7-400 has been designed for production automation. It is based on the associated standard CPU whose hardware and operating system have been expanded to execute safety programs and various protective measures.

All programming of the safety-relevant program is carried out with STEP 7 in the standard LAD and FBD languages.

The software package "Distributed Safety" supports parameterization of the fail-safe I/O and programming by means of predefined, certified software blocks.

## Process automation

The fault-tolerant CPUs 414H and 417H of the S7-400 are available for use in the process industry. Safety-relevant applications in the process industry require a special software package "S7 F-Systems". Fail-safe applications with SIL 3 can be solved with one CPU.

Two redundant CPUs can be used for enhanced system availability in order to comply with the demands for fail-safety and fault-tolerance.

Drafting of the program is carried out using the Safety Matrix or Continuous Function Chart (CFC) as well as certified function blocks.

"S7 F-Systems" supports configuration of the safety-relevant I/O and programming of the logic functions.

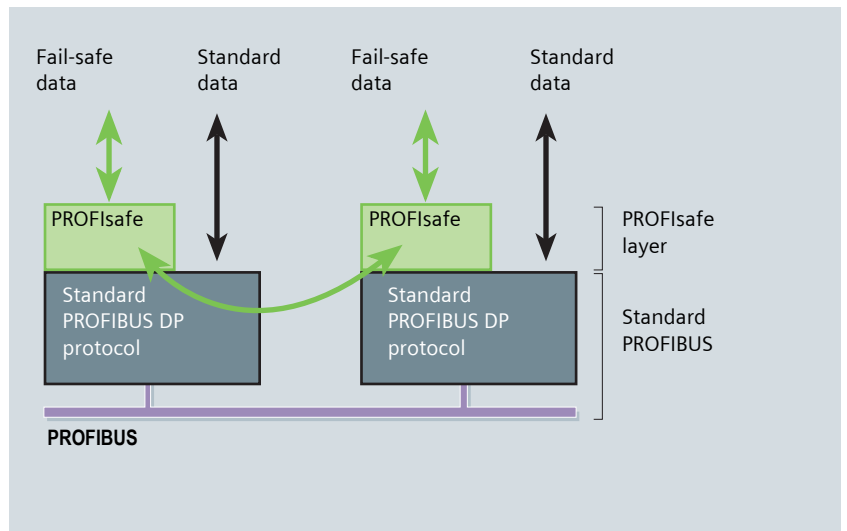

Standard and safety-relevant data are transmitted on the same bus cable using PROFIsafe

# Configuration and programming with STEP 7

The basis for configuration and programming of the SIMATIC S7-300, S7-400, C7 and WinAC is STEP 7. This uniformity makes it possible to transfer applications to different platforms.

## STEP 7

STEP 7 offers functions for every phase of an automation project – from configuration to startup, testing and servicing, and thus supports the complete engineering workflow.

STEP 7 incorporates both the hardware configuration of the plant and the parameterization of the modules, so there are no more hardware settings to be made. Using STEP 7, the communications links within a project are defined on a GUI. The SIMATIC Manager for STEP 7 is the central tool for project management. The SIMATIC Manager not only provides a view of a CPU but also of the complete plant irrespective of the number of PLCs, drives and HMI units present in the solution.

For development of the user program, STEP 7 includes three basic languages: statement list (STL), ladder diagram (LAD) and function block diagram (FBD). These are standardized according to IEC 1131-3 and used globally as the international standard.

## STEP 7 Professional

STEP 7 Professional is recommended for larger applications. This package includes all programming languages standardized according to IEC 1131-3, i.e. in addition to statement list (STL), ladder diagram (LAD) and function block diagram (FBD):

- S7-SCL (Structured Control Language), the PASCAL-based higher-level language for programming complex algorithms and mathematical functions or for tasks associated with data processing.

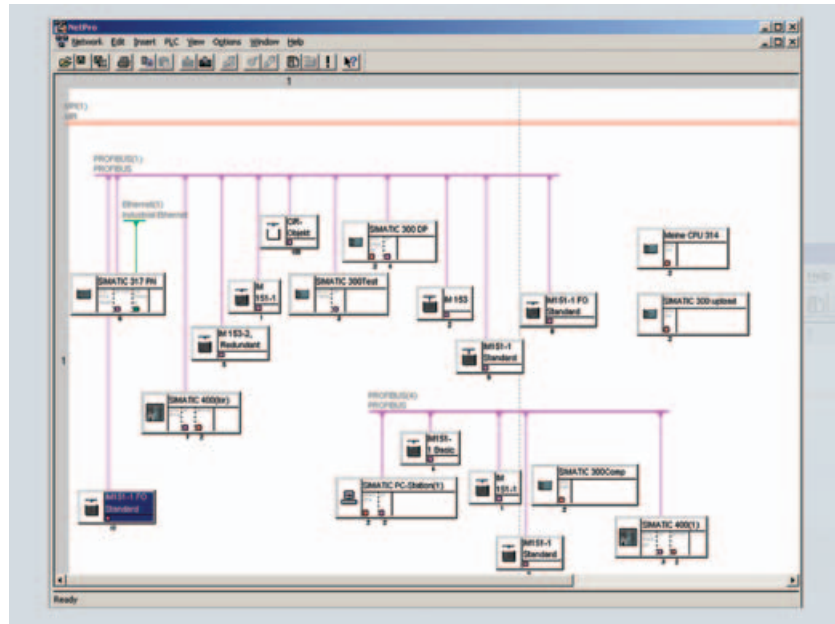

Graphic configuration of communication links in NetPro

- S7-GRAPH enables graphical configuration of sequential control systems. S7-GRAPH is used to describe sequential operations with alternative or parallel step sequences.
- S7-PLCSIM for simulation of a test environment including PLC and process. S7-PLCSIM enables testing of the program before it is loaded into the plant's PLC.

## Further engineering tools

Further engineering tools are available for special applications, for example:

- S7-HiGraph for automation of function units with status diagrams. This method is used to graphically describe statuses and step criteria.
- CFC (Continuous Function Chart), the technology-oriented diagram which enables graphical interconnection of complex functions, for example in process engineering.

## Data storage

The Memory Card allows user programs and any data to be saved to the CPU. If you are servicing or upgrading the system, this provides the advantage that the personnel can still access the currently executed programs as well as the whole project, including any comments and symbols on site. If you are using higher-level languages or graphical engineering tools, the program source code is also immediately available in its original form or in graphical format. Last but not least, it is also possible to save customer-specific operating instructions, manuals and machine documentation directly on the CPU in all standard file formats.

# Communications networks – Ethernet, PROFIBUS and more

The following bus systems are available for SIMATIC:

- Industrial Ethernet (IEEE 802.3 and 802.3u) – the international standard for area and cell networking is the number one in the global LAN landscape with a share of more than 80%. Industrial Ethernet can be used to design powerful communications networks covering a wide area.
- PROFINET – the international standard uses Industrial Ethernet, and permits real-time communication down to the field level. With full utilization of existing IT standards, PROFINET also permits isochronous motion control applications on the Industrial Ethernet.
- PROFIBUS (IEC 61158 / EN 50170) – the international standard for the cell and field levels is the global leader for fieldbuses. It is the only fieldbus which permits communication in both production-oriented and process-oriented applications.
- As a low-price alternative to a cable harness, the AS-Interface links sensors and actuators by means of a two-wire cable.
- The basis for building services automation is the worldwide standard KNX (EN 50090, ANSI EIA 776).
- Point-to-point connection – the simplest form of communication between two stations. Special protocols are used, e.g. RK 512, 3964(R), ASCII, (see page 19).
- Routers are implemented using controllers or links.

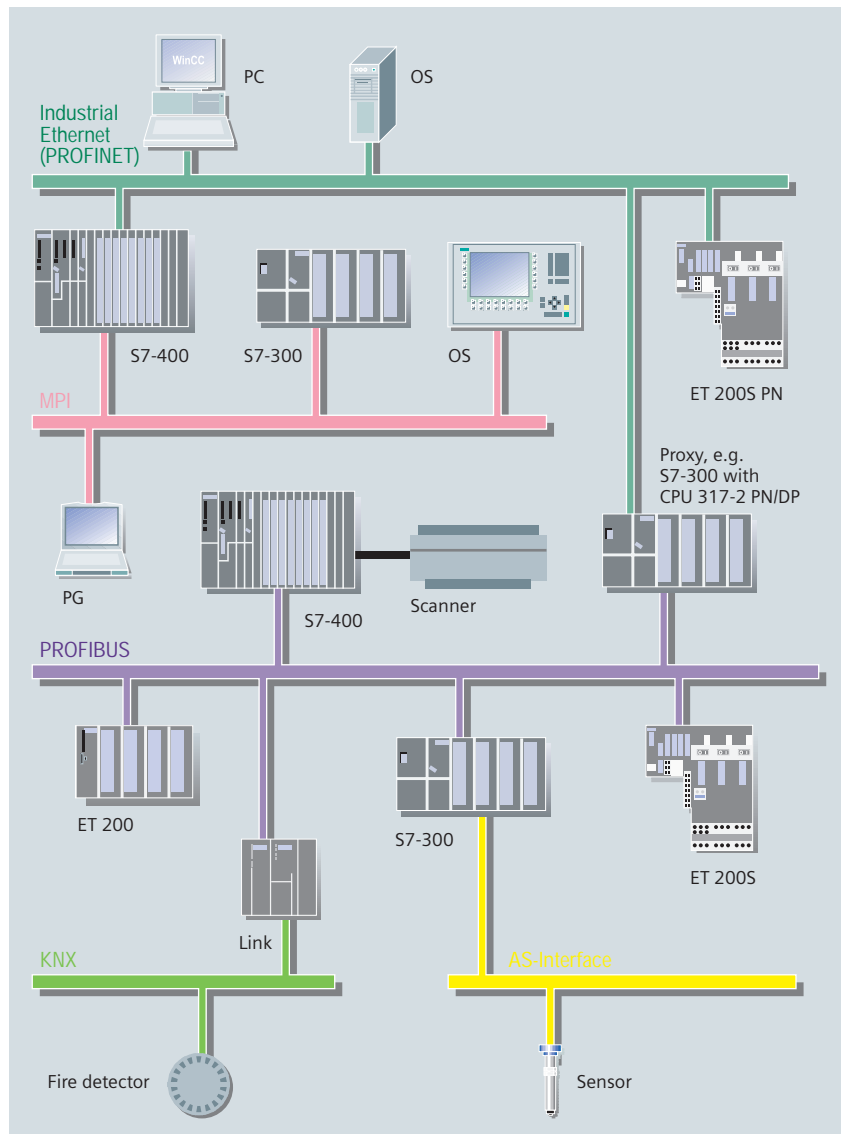

Communications options of the SIMATIC S7-400

# PROFINET – the open Industrial Ethernet standard

Uniform communication from the field level up to the operations management level is currently one of the most important demands placed on automation technology. Standardized connection systems, uniform network management, IT access mechanisms and comprehensive diagnostics facilities permit savings to be made covering planning, commissioning and operation. It should be possible to use the advantages of the rugged fieldbuses as well as the standardized IT functionality of Ethernet for the uniform communication. With PROFINET, PROFIBUS International (PI) has defined a comprehensive standard which opens up new possibilities for the field area:

- IT integration
- Distributed automation
- Use of industrial wireless LAN
- Real-time

PROFINET is the open and cross-vendor Industrial Ethernet standard for all automation levels and applications.

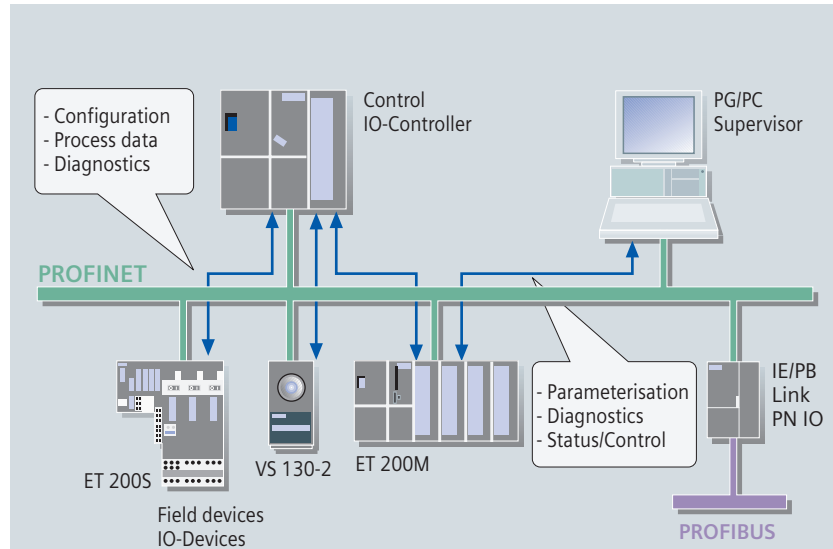

PROFINET IO with distributed field devices

## PROFINET IO

PROFINET IO is used to directly link distributed field devices to Industrial Ethernet. In the proven configuration with STEP 7 known from PROFIBUS, these field devices (IO device) are assigned to a central controller (IO controller).

In order to provide safeguarding of investments, existing modules or devices can be used further with PROFINET-capable interfaces or links. An IO supervisor is used for HMI and diagnostics purposes (overview and detailed diagnostics).

The following products from the S7-400 environment are available, and can be configured using STEP 7:

- IM 151-3 PN: direct connection of ET 200S as IO device to Industrial Ethernet
- CP 443-1 ADVANCE: communications module for expansion of the S7-400 by an Industrial Ethernet interface in order to connect field devices as IO device to Industrial Ethernet via S7-400

Flexibility through use of Ethernet and proven IT standards

Savings during engineering and commissioning through modularization

Safeguarding of investments for PROFIBUS devices and applications

Increase in performance by a factor of 100 for motion control applications

PROFINET - the main topics

# Powerful networking – via integral interfaces

The S7-400 provides a connection to all standard bus systems.

Connection of sensors/actuators to the S7-400 is supported by PROFIBUS DP and PROFINET IO. To make this possible, the S7-400 can be connected as a master - either by means of the interface integrated into each CPU, a special interface module or a communications processor (CP).

The AS Interface and KNX networks and other bus systems are accessible from the S7-400 through the PROFIBUS gateways.

Data transfer to other automation systems or intelligent partners (PC, computer, etc.) is implemented via the MPI interface, PROFIBUS or Industrial Ethernet. The MPI interface on each CPU enables simple cyclic data transfer on the one hand (no acknowledgment) and programmed transfer of relatively large volumes of data on the other (with or without acknowledgment). Specific communications processors (CP) are used for the connection to PROFIBUS, PROFINET or Industrial Ethernet.

A point-to-point coupling via PtP CPs is used for simple communications tasks.

## Integral interfaces

Interfaces directly integrated in the CPUs permit the design of a powerful communications landscape with application of standard bus technology, e.g. for HMI and programming device functions. Sufficient connection resources are available to permit the connection of many HMI devices. Using a routing function, a programming device connected at any position of the network can access all stations of the network.



*Powerful networking with integral interfaces of CPU and communications processor*

## Multipoint interface MPI

MPI is the low-cost solution for communication with programming devices/PCs, HMI systems and further SIMATIC S7/C7/WinAC automation systems. Max. 125 MPI stations can be connected at up to 12 Mbit/s, e.g. for exchanging process data between different PLCs or for HMI tasks without programming overhead. The MPI can also be used as a PROFIBUS DP interface, and permits the configuration of a further DP segment.

## PROFIBUS DP

The economical design of larger distributed structures is possible by connecting the SIMATIC S7-400 to the open PROFIBUS DP fieldbus (IEC 61158 / EN 50170). This opens up communications possibilities to a large number of partners, from the SIMATIC PLC right up to field devices from other vendors. Communication with existing SIMATIC S5 or SIMATIC 505 systems is possible. Configuration of the distributed I/O is carried out using STEP® 7 as with the central I/O, thus saving engineering overhead.

Supporting of the DP V1 functionality permits parameterization and optimization of field devices during runtime and thus shorter machine setup times. Detailed device diagnostics additionally reduces the plant downtimes.

## Communications interface modules

Communications interface modules can be optionally used in the S7-400 CPUs in order to adapt these to the requirements of the respective application.

For this purpose, the CPUs 414-3 and 416-3 have one vacant slot, and the CPU 417 has two vacant slots. By adding such interface modules, additional DP segments can be designed as master or slave whose functionality corresponds to that of the integral interface.

# Versatile module spectrum

The versatile module spectrum permits modular adaptation of the SIMATIC PLC to highly different tasks.

The following are available:

- Signal modules (digital and analog I/O modules) for almost all types of signal, also with interrupt processing and diagnostics
- Function modules for technological tasks, e.g. counting/measurement, all types of positioning functions, cam control and computing
- Communications modules for serial point-to-point connections and the connection of networks, e.g. PROFIBUS, PROFINET, Industrial Ethernet with IT functionality
- Load power supplies to secure the supply of all operating voltages for the other modules (but not the load voltages for signal modules)
- Interface modules for connecting racks in the case of a multi-tier design.

## Signal modules

However, the S7-400 signal modules only represent a subset of the modules which can be connected to the S7-400 via PROFIBUS DP. Hot swapping of signal modules inserted in the central controller is possible.

Criteria are presented on the following pages which permit selection of the appropriate signal module for a respective application.

Comprehensive and continuously updated technical specifications can be found in the interactive Catalog CA 01 on the Internet:

[www.siemens.com/automation/ca01](http://www.siemens.com/automation/ca01)

## Function modules

Function modules are available for the following technological applications:

- Counting in various modes, up to 500 kHz
- Cam control for up to 16 cam lines per module
- Any type of positioning function: controlled positioning using the rapid/creep feed process (3 axes per module)
- Point-to-point positioning and velocity profiles (position control) with stepper and servo motors (3 axes per module)
- PID controller with backup functionality and integrated online self-configuration for various types of controller (continuous controllers, stepper controllers, pulse controllers)
- Freely programmable highly dynamic controller for up to 100 axes per module

## Communications

Communications modules are available for the following applications:

- Point-to-point connection with data rates of up to 115 Kbit/s and various protocols, e.g. for connecting modems, printers, scanners, drives, external devices, etc.
- Connection to PROFIBUS using either the DP or the FMS protocol (DP V0 and DP V1)
- Connection to Industrial Ethernet using the ISO/TCP or TCP/IP data communications protocol and PROFINET
- Connection to the Internet through Ethernet for loading Web sites and using e-mail

## Power supplies

The power supplies are also available in a version with diagnostics capability, and can be provided with a redundant design if necessary to increase the PLC availability.

## Interfacing to the IT world

The SIMATIC permits simple interfacing of the modern IT world to the automation technology. The following functions are possible using the plug-in IT-CP:

- Creation of your own Web sites using any HTML tools, and the process variables for the S7 can simply be assigned to the HTML objects.
- Monitoring of the S7 through these Web sites using a standard browser.
- Sending of e-mails from the user program of the S7 by means of function calls.
- Remote programming through the telephone network (e.g. ISDN) using the WAN properties of TCP/IP.

# Cost-effective point-to-point coupling

Point-to-point coupling using communications processors (CPs) is a very powerful and cost-effective alternative to bus systems.

The advantage of a point-to-point coupling compared to bus systems is particularly evident if only a few (RS 485) devices are to be connected to the SIMATIC S7.

The CPs can also link third-party systems to the SIMATIC S7 cost-effectively. Because of the greater flexibility of the CPs, it is possible to implement different physical transmission systems, transmission rates or even customized transmission protocols.

The CPs have a rugged plastic housing with LEDs for display of operating states and faults.

A configuration package is available on CD for each CP with electronic manual, parameterization screen forms, and standard function blocks for communication between the CPU and CP.

The configuration data are stored in a system data block which is saved in the CPU. Following replacement of a module, the new module is therefore immediately ready for operation.

With the S7-400 point-to-point coupling modules, adaptation to the physical transmission system is carried out by plugging in corresponding interface modules without the use of external converters.

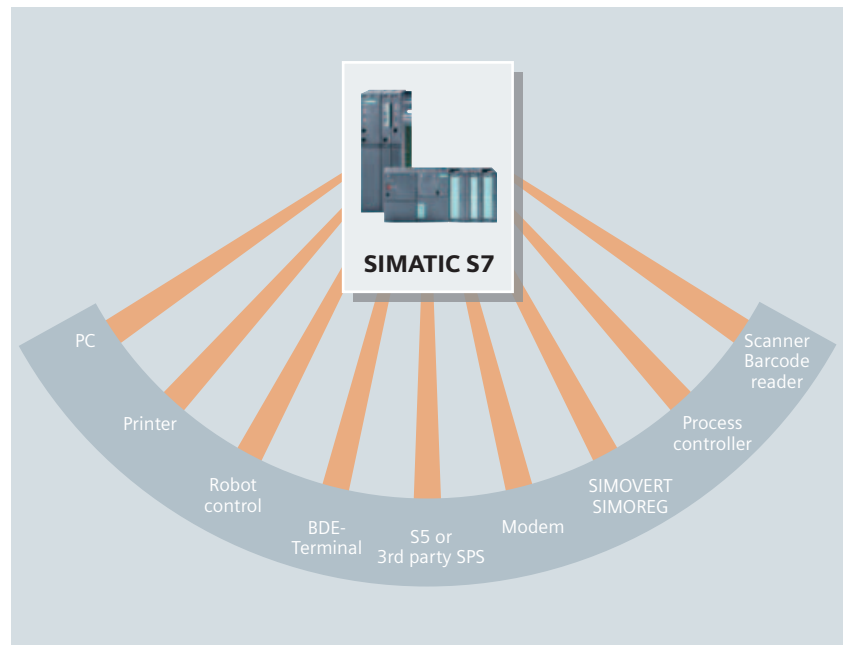

Communications facilities of the SIMATIC S7-400

Technical specifications of the S7-400 point-to-point CPs			
Application	Fast response with small data quantities	Coupling	
		Low-cost with one variable interface	High-speed with two variable interfaces
<b>Transmission rate</b>	High (115200 bit/s)	Low (38400 bit/s)	High (115200 bit/s)
<b>Loadable protocols</b>	–		Modbus master (6ES7 340-1AA..-...) Modbus slave (6ES7 340-1AB..-...) Data highway (6ES7 340-1AE..-...)
<b>Module</b>	CP440	CP 441-1	CP 441-2
<b>MLFB group: 6ES7</b>	440 -1....	441-1....	441-2....
<b>Physical transmission system</b>	<ul style="list-style-type: none"> <li>• RS 232C (V.24) –</li> <li>• 20 mA (TTY) –</li> <li>• RS 422/485 (X.27) Yes (up to 32 stations)</li> </ul>		All transmission systems, all interface modules, plug-in, serial
<b>Integral transmission protocols</b>			
<ul style="list-style-type: none"> <li>• ASCII</li> <li>• Printer drivers</li> <li>• 3964(R)</li> <li>• RK512</li> </ul>	<ul style="list-style-type: none"> <li>✓</li> <li>–</li> <li>✓</li> <li>–</li> </ul>	<ul style="list-style-type: none"> <li>✓</li> <li>✓</li> <li>✓</li> <li>–</li> </ul>	<ul style="list-style-type: none"> <li>✓</li> <li>✓</li> <li>✓</li> <li>✓</li> </ul>

# Signal modules for sensors and actuators

Signal modules are the interface of the PLC to the process. A wide range of different digital and analog modules make those I/Os available which are required for the respective task.

## Easy to install

The sensors/actuators simply connect to the front connector. When replacing the module, all you need to do is plug the connector into the new module of the same type. You do not need to change the wiring. The coding of the front connector prevents confusing of modules.

## Fast connection

Using SIMATIC TOP connect makes it even easier to connect (not for the onboard I/Os of the S7-300 compact CPUs). You can choose between prewired front connectors with individual strands and a completely modular building block system, consisting of front connector module, cable and terminal block.

## High level of packaging density

The large number of channels on the modules is one reason for the space-saving design, e.g. modules are available with 8 to 32 digital channels.

## Simple to configure

The modules are configured and parameterized using STEP 7, there are no fiddly switch settings. The data are stored centrally and automatically transferred to the new module after a module is replaced, which prevents setting faults. No software upgrade is required when new modules are installed. Configurations which have been carried out once, e.g. for series machines, can be identically repeated as often as required.

## Diagnostics, interrupts

Many modules also monitor signal acquisition (diagnostics interrupt) and the signals from the process (process interrupt, e.g. evaluation of edges). This means the system can react quickly to any irregularities and to every process event. How and whether the controller reacts can be configured in STEP 7. For the digital input modules, several interrupts are also possible per module.

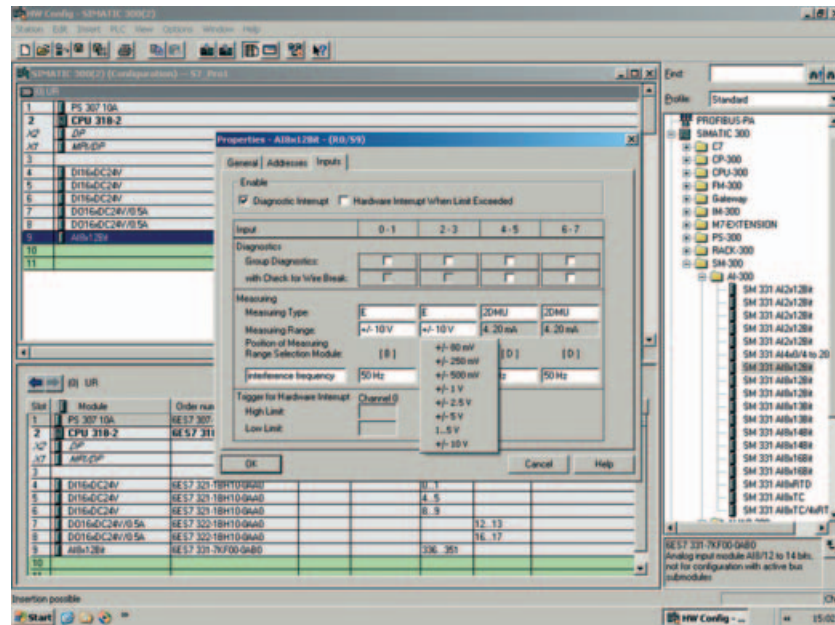

Parameterization of an analog input module

# I/Os – selection guide for digital inputs/outputs

Module type	Digital inputs				
<b>Special features of this module</b>	Very fast, interrupt-capable 24 V DC input module	24 V DC standard input module – extremely high packaging density	Highest packaging density for the 120 V market	Input module for higher, variable voltages	Interrupt-capable input module for lower, variable voltages <sup>1)</sup>
<b>Type of voltage</b>	DC		AC/DC		
<b>Input voltage</b>	24 V		120 V	120/230 V	24 to 60 V
<b>Interrupt capability</b>	✓	–			✓
<b>Input delay</b>	0.05 to 3 ms <sup>2)</sup>	3 ms	< 25 ms		0.5 to 20 ms <sup>2)</sup>
<b>Num. of channels</b>	16	32		16	
<b>MLFB group: 6ES7 421-</b>	7BH...-	1BL...-	1EL...-	1FH...-	7DH...-

Module type	Digital outputs				
<b>Special features of this module</b>	DC output module for high currents	24 V DC standard output module – highest possible packaging density	Very fast, interrupt-capable 24 V DC input module	AC standard output module	Relay output module
<b>Type of voltage</b>	DC			AC	Relay
<b>Output voltage</b>	24 V			120/230 V	5-125 V DC
<b>Output current</b>	2 A	0.5 A	2 A		5 A
<b>Interrupt capability</b>	–		✓	–	
<b>Num. of channels</b>	16	32		16	
<b>MLFB group: 6ES7 422-</b>	1BH...-	1BL...-	7BL...-	1FH...-	1HH...-

<sup>1)</sup> can also be used as an active low module

<sup>2)</sup> can be set with parameters

# I/Os – selection guide for analog inputs

Module type	Analog inputs					
<b>Physical variable</b>	Voltage					
<b>Special features of this module</b>	Standard module with 16 inputs	Standard module with 8 inputs	Numerous voltage ranges	Very rapid analog value acquisition	Generation of diagnostics and process value interrupts at 16 bit resolution	Channel-oriented isolation and generation of diagnostic and process value interrupts
<b>Measurement range Encoder</b>	±1 V 1 - 5 V	±1 V ±10 V 1 - 5 V	±80 mV ±250 mV ±500 mV ±1 V ±2,5 V ±5 V ±10 V 1 - 5 V	±1 V 1 - 5 V ±10 V	±25 mV ±50 mV ±80 mV ±250 mV ±500 mV ±1 V ±2.5 V ±5 V ±10 V 1 - 5 V	±25 mV ±50 mV ±80 mV ±250 mV ±500 mV ±1 V ±2.5 V ±5 V ±10 V 1 - 5 V
<b>Interrupt capability</b>	–				✓	
<b>Isolation</b>	–	✓				
<b>Number of channels</b>	16	8			16	8
<b>Resolution</b>	13 bit		14 bit		16 bit	
<b>Conversion time per channel</b>	55/65 ms	23/25 ms	20/23 ms	52 µs	6/21/23 ms	–
<b>MLFB group</b>	6ES7 431-0HH-....	6ES7 431-1KF0-....	6ES7 431-1KF1-....	6ES7 431-1KF2-....	6ES7 431-7QH-....	6ES7 431-7KF0-....

Module type	Analog inputs					
<b>Physical variable</b>	Current					
<b>Special features of this module</b>	Standard module with 16 inputs	Standard module with 8 inputs	Standard module with 8 inputs	Very rapid analog value acquisition	Generation of diagnostics and process value interrupts at 16 bit resolution	Channel-oriented isolation and generation of diagnostic and process value interrupts
<b>Measurement range Encoder</b>	4-20 mA ±20 mA	4 - 20 mA ±20 mA	4 - 20 mA 0 - 20 mA	4 - 20 mA ±20 mA	4 - 20 mA 0 - 20 mA ±5 mA ±10 mA ±20 mA	4 - 20 mA 0 - 20 mA ±5 mA ±10 mA ±20 mA ±3.2 mA
<b>Interrupt capability</b>	–				✓	
<b>Isolation</b>	–	✓				
<b>Number of channels</b>	16	8			16	8
<b>Resolution</b>	13 bit		14 bit		16 bit	
<b>Conversion time per channel</b>	55/65 ms	23/25 ms	20/23 ms	52 µs	6/21/23 ms	–
<b>MLFB group</b>	6ES7 431-0HH-....	6ES7 431-1KF0-....	6ES7 431-1KF1-....	6ES7 431-1KF2-....	6ES7 431-7QH-....	6ES7 431-7KF0-....

# I/Os – selection guide for analog inputs

Module type	Analog inputs			
Physical variable	Resistance			
Special features of this module	Standard module	Numerous measurement ranges	High-speed analog value acquisition and generation of process interrupts	Many measurement ranges and generation of process and diagnostics interrupts
Encoder measurement range	0 - 600 Ω	0 - 48 Ω, 0 - 150 Ω, 0 - 300 Ω, 0 - 600 Ω, 0 - 6000 Ω	0 - 600 Ω	0 - 48 Ω, 0 - 150 Ω, 0 - 300 Ω, 0 - 600 Ω, 0 - 6000 Ω
Interrupt capability	–			✓
Isolation	✓			
Number of channels	4			8
Resolution	13 bit	14 bit		16 bit
Conv. time per channel	23/25 ms	20/23 ms	52 μs	6/21/23 ms
MLFB group	6ES7 431-1KF0.-....	6ES7 431-1KF1.-....	6ES7 431-1KF2.-....	6ES7 431-7QH.-....

Module type	Analog inputs		
Physical variable	Thermocouples		
Special features of this module	Standard module with 8 channels	16 channels with 16 bit resolution and generation of process and diagnostics interrupts	Channel-oriented isolation and generation of process and diagnostics interrupts
Types	B, E, N, J, K, L, R, S, T, U		
Interrupt capability	–	✓	
Isolation	✓	✓	
Number of channels	8	16	8
Resolution	14 bit	16 bit	
Conv. time per channel	20/23 ms	6/21/23 ms	–
MLFB group	6ES7 431-1KF1.-....	6ES7 431-7QH.-....	6ES7 431-7KF0.-....

Module type	Analog inputs		
Physical variable	Resistance thermometer		
Special features of this module	Standard module with 4 channels	Generation of process and diagnostics interrupts	Generation of process and diagnostics interrupts
Types	Pt 100, Pt 200, Pt 500, Pt 1000, Ni 100	Pt 100, Pt 200, Pt 500, Pt 1000, Ni 100, Ni 1000	
Interrupt capability	–	✓	
Isolation	✓		
Number of channels	4	8	
Resolution	14 bit	16 bit	
Conv. time per channel	20/23 ms	6/21/23 ms	–
MLFB group	6ES7 431-1KF1.-....	6ES7 431-7QH.-....	6ES7 431-7KF1.-....

# I/Os – selection guide for analog outputs, standards

Module type	Analog outputs
Physical measured variable	Voltage, current
Encoder measurement range	±10 V, 0 - 10 V, 1 - 5 V, ±20 mA, 0 - 20 mA, 4 - 20 mA
Interrupt capability	–
Isolation	✓
Number of channels	8
Resolution	13 bit
Conversion time per channel	420 µs
MLFB group	6ES7 432-1HF... ..

Standards	
The SIMATIC S7-400 fulfills the following national and international standards:	• DIN, EN, IEC
	• UL certificate
	• CSA certificate
	• FM class 1 div. 2; group A, B, C and D
	• Temperature group T4 (≤ 135 °C)
	• Marine approvals from <ul style="list-style-type: none"> <li>– American Bureau of Shipping</li> <li>– Bureau Veritas</li> <li>– Des Norske Veritas</li> <li>– Germanischer Lloyd</li> <li>– Lloyds Register of Shipping</li> </ul>
	• Ambient temperature 0 to 60 °C for all components
	• Earthquake-proof

Product briefs on further versions of the S7-400 for special applications
Fail-safe SIMATIC PLCs 6ZB5310-OKE01-OBA.
Fault-tolerant SIMATIC PLCs 6ZB5310-OFW01-OBA.
Technological tasks with SIMATIC E20001-A430-P210
WinAC PC-based 6ZB5310-OKP01-OBA.
Isochrone mode 6ZB5310-OKV01-OBA.
AS-Interface E20001-A150-P302
Industrial Ethernet 6ZB5530-OAK01-OBA.
PROFINET 6ZB5310-OMA01-OBA0
PROFIBUS 6ZB5530-OAQ01-0BB.

You can find more detailed information in the **SIMATIC Guide documentation**:

[www.siemens.com/simatic-docu](http://www.siemens.com/simatic-docu)

You can order **further documents** on the topic of SIMATIC at:

[www.siemens.com/simatic/printmaterial](http://www.siemens.com/simatic/printmaterial)

To arrange a **personal discussion** you can find your local contact at:

[www.siemens.com/automation/partner](http://www.siemens.com/automation/partner)

In the A&D Mall you can place orders **directly via the Internet**:

[www.siemens.com/automation/mall](http://www.siemens.com/automation/mall)

The information provided in this brochure contains descriptions or characteristics of performance which in case of actual use do not always apply as described or which may change as a result of further development of the products.

An obligation to provide the respective characteristics shall only exist if expressly agreed in the terms of contract. Availability and technical specifications are subject to change without notice.

All product designations may be trademarks or product names of Siemens AG or supplier companies whose use by third parties for their own purposes could violate the rights of the owners.