

HARTING



Han-Kit® Complete Connector Sets

Industrial Connectors for Applications
up to 500 V / 16 A

Economical and Reliable Connections - 1 Kit per Package - Easy Choice for You!

Specifications

VDE 0110 Table for clearance and creepage distances
 DIN EN 61 984
 VDE 0627 Connectors
 Safety requirements and Tests

Standards

DIN EN 175 301-801

Approvals

UL, CSA, SEV for inserts



Certified accd. to EN ISO 9001
 in design/ development, production,
 installation and service.

General Remarks:

It is the user's responsibility to check whether the componenets belonging to these kits comply with different regulations from those stated in special fields of application which we are unable to foresee.
 We reserve the right to modify designs in order to improve quality and keep pace with technological requirements in production.
 No part of this information leaflet must be reproduced in any form (print, photocopy, microfilm or any other process) processed, duplicated or distributed by means of electronic systems without the written permission of HARTING ELectric GmbH & Co. KG, Espelkamp (Copyright Law, Fair Trading Law, Civil Code).
 We are bound by the German version only.

Note

Connectors should not be coupled or decoupled under electrical load.
Connectors of the same or different series being mounted side by side may be protected against incorrect mating by the use of coding options.

Han® 3 A

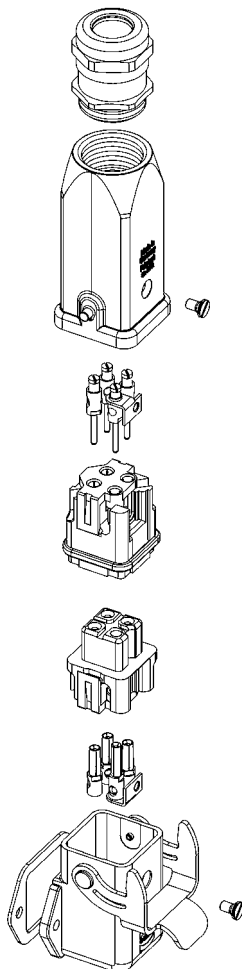

Connector Set Up

Cable Gland

Hood

Male contacts

Male insert

Female insert

Female contacts

Bulkhead mounted housing

Han® 10 B

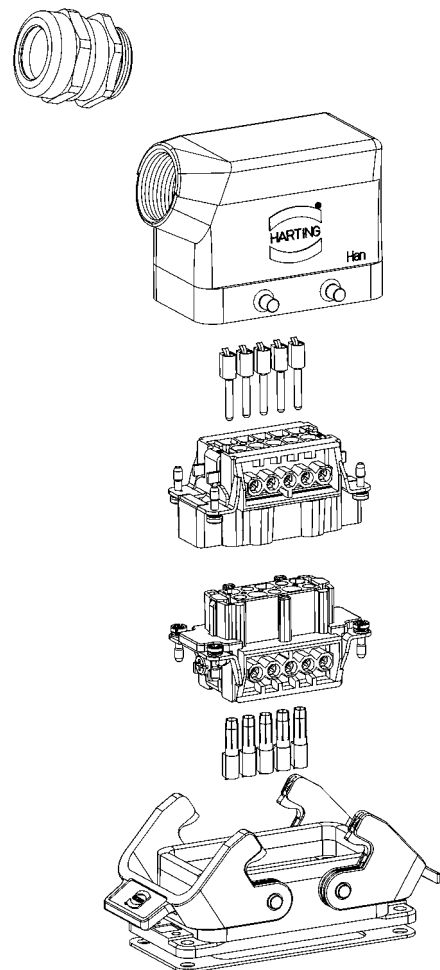

Screw Terminal

| Inserts | Stripping length a (mm) | Sheath length x (mm) |
|--------------------|----------------------------|-------------------------|
| Han 3A ... + 4A... | 4.5 | 40 |
| Han 10 A | 7 | 85 |
| Han 16 A | 7 | 100 |
| Han 6 E | 7 | 70 |
| Han 10 E | 7 | 90 |
| Han 16 E | 7 | 110 |
| Han 24 E | 7 | 130 |

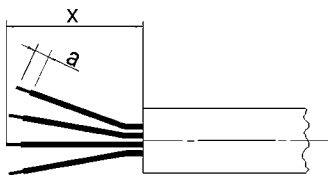

| Recommended Tightening Torques and Screw Driver Blades | | | | |
|--|--|------------------------|----------------------------|---------------------------------|
| Size of screw | Type of connector | Tightening torque [Nm] | Tightening torque [lbf·ft] | Recomm. screw driver blade [mm] |
| M3 | Screw terminal Han 3A.../4A... | 0.25 | 0.4 | 0.5 x 2.5 |
| M3 | Screw terminal Han 10A + 16A Han 6B - 24 B | 0.5 | 0.4 | 0.5 x 3.5 |
| M3.5 | PE contact Han 10A + 16A | 1.2 | 0.9 | 0.5 x 3.5 |
| M4 | PE contact Han 6B - 24 B | 1.2 | 0.9 | 0.5 x 3.5 |

Derating Diagrammes



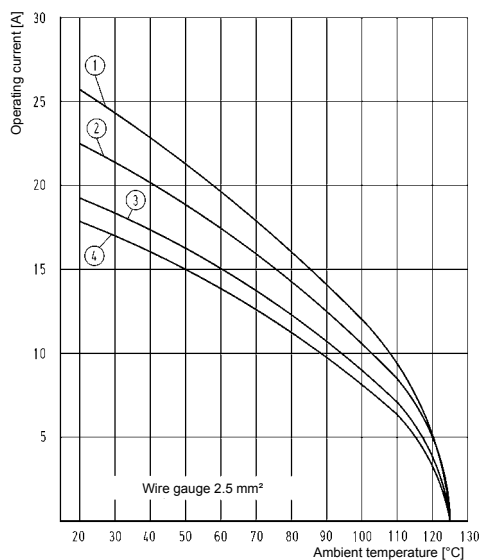

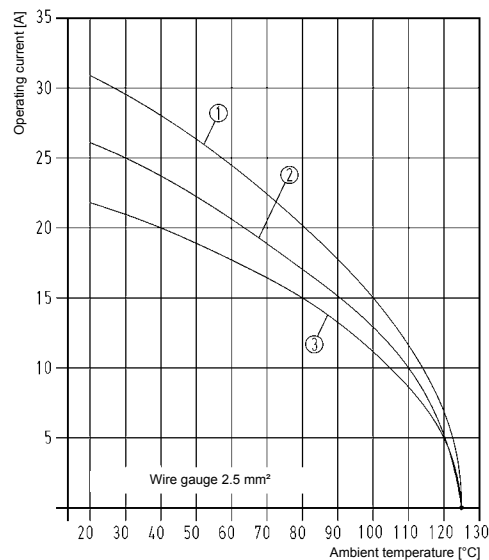

The current carrying capacity is limited by the thermal properties of materials which are used for inserts as well as by the insulation materials. The rated current is the continuous, not interrupted current a connector can take when simultaneous power on all contacts is given, without exceeding the maximum temperature according to DIN IEC 60 512-3.

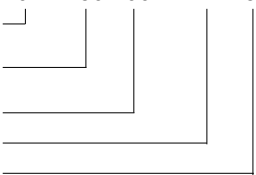

- 1 = Han 6 E
- 2 = Han 10 E
- 3 = Han 16 E
- 4 = Han 24 E

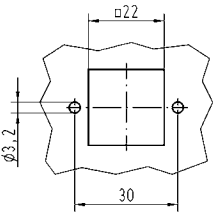
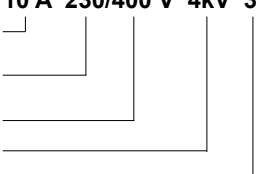

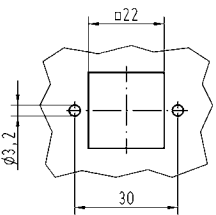
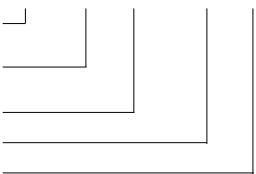
- 1 = Han 3 A / 4 A
- 2 = Han 10 A
- 3 = Han 16 A

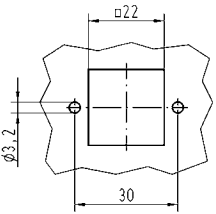
| Han® 3 A Metal Version | Part-Number | Dimensions in mm |
|--|---|--|
| <p>Han-Kit®-3AGM</p> <p>Hood Han® 3 A straight Bulkhead mounted hous.¹⁾ Han® 3 A straight Material Die cast zinc alloy Protection degree²⁾ IP 67 Cable gland M20, metal Cable diameter 5 - 9 mm / 6 - 12 mm Insert Han® 3 A, 3-pins + PE Screw terminal 1-2.5 mm², AWG 18-14 Electrical data accd. to DIN EN 61 984³⁾ 10 A 230/400 V 4kV 3</p>  <p>Rated current Rated voltage conductor-ground Rated voltage conductor-conductor Rated impulse voltage Pollution degree Rated voltage accd. to UL/CSA 600 V</p> | <p>10 20 003 0001</p> |  <p>Assembly cut out bulkhead mounted housing 22 x 22 mm</p>  |
| <p>Han-Kit®-3AWM</p> <p>Hood Han® 3 A straight Bulkhead mounted hous.¹⁾ Han® 3 A angled Material Die cast zinc alloy Protection degree²⁾ IP 67 Cable gland M20, metal Cable diameter 5 - 9 mm / 6 - 12 mm Insert Han® 3 A, 3-pins + PE Screw terminal 1-2.5 mm², AWG 18-14 Electrical data accd. to DIN EN 61 984³⁾ 10 A 230/400 V 4kV 3</p>  <p>Rated current Rated voltage conductor-ground Rated voltage conductor-conductor Rated impulse voltage Pollution degree Rated voltage accd. to UL/CSA 600 V</p> | <p>10 20 003 0003</p> |  <p>Assembly cut out bulkhead mounted housing 22 x 22 mm</p>  |
| <p>Han-Kit®-3AWSM</p> <p>Hood Han® 3 A angled Bulkhead mounted hous.¹⁾ Han® 3 A straight Material Die cast zinc alloy Protection degree²⁾ IP 67 Cable gland M20, metal Cable diameter 5 - 9 mm / 6 - 12 mm Insert Han® 3 A, 3-pins + PE Screw terminal 1-2.5 mm², AWG 18-14 Electrical data accd. to DIN EN 61 984³⁾ 10 A 230/400 V 4kV 3</p>  <p>Rated current Rated voltage conductor-ground Rated voltage conductor-conductor Rated impulse voltage Pollution degree Rated voltage accd. to UL/CSA 600 V</p> | <p>10 20 003 0005</p> <p>1) Bulkhead mounted housing with flange gasket 2) Protection degree accd. to DIN EN 60 529 in locked position 3) For only use in grounded circuits</p> |  <p>Assembly cut out bulkhead mounted housing 22 x 22 mm</p>  |

Han® 3 A Plastic Version

Part-Number

Dimensions in mm

Han-Kit®-3AGK

Hood Han® 3 A straight
 Bulkhead mounted hous.¹⁾ Han® 3 A straight
 Material Plastic
 Protection degree²⁾ IP 67
 Cable gland M20, plastic
 Cable diameter 5 - 9 mm / 6 - 12 mm
 Insert Han® 3 A, 3-pins + PE
 Screw terminal 1-2.5 mm², AWG 18-14

10 20 003 0002

Electrical data accd. to DIN EN 61 984³⁾
10 A 230/400 V 4kV 3

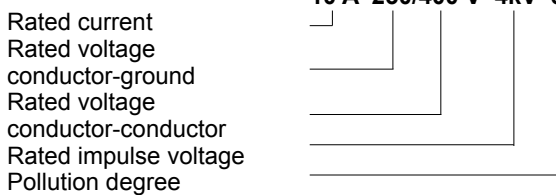

Rated voltage accd. to UL/CSA 600 V



Assembly cut out bulkhead mounted housing 22 x 22 mm

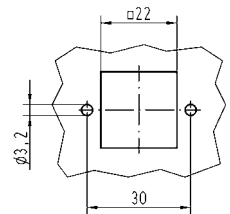

Han-Kit®-3AWK

Hood Han® 3 A straight
 Bulkhead mounted hous.¹⁾ Han® 3 A angled
 Material Plastic
 Protection degree²⁾ IP 67
 Cable gland M20, plastic
 Cable diameter 5 - 9 mm / 6 - 12 mm
 Insert Han® 3 A, 3-pins + PE
 Screw terminal 1-2.5 mm², AWG 18-14

10 20 003 0004

Electrical data accd. to DIN EN 61 984³⁾
10 A 230/400 V 4kV 3

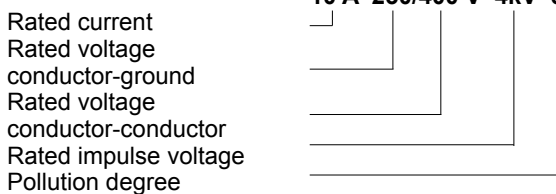





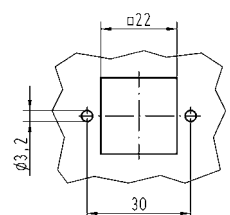

Rated voltage accd. to UL/CSA 600 V

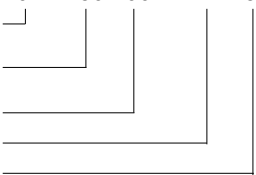

Assembly cut out bulkhead mounted housing 22 x 22 mm

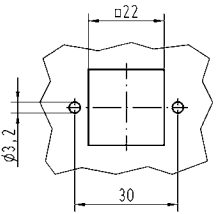
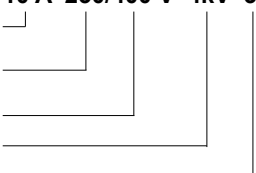

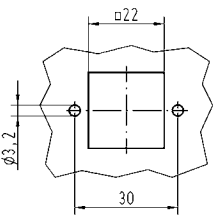
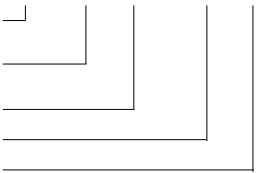
- 1) Bulkhead mounted housing with flange gasket
- 2) Protection degree accd. to DIN EN 60 529 in locked position
- 3) For only use in grounded circuits

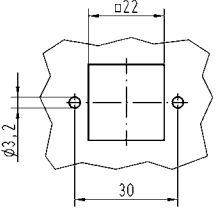
| Han® 4 A Metal Version | Part-Number | Dimensions in mm |
|--|---|--|
| <p>Han-Kit®-4AGM</p> <p>Hood Han® 3 A straight Bulkhead mounted hous.¹⁾ Han® 3 A straight Material Die cast zinc alloy Protection degree²⁾ IP 67 Cable gland M20, metal Cable diameter 5 - 9 mm / 6 - 12 mm Insert Han® 4 A, 4-pins + PE Screw terminal 1-2.5 mm², AWG 18-14 Electrical data accd. to DIN EN 61 984³⁾ 10 A 230/400 V 4kV 3</p>  <p>Rated current Rated voltage conductor-ground Rated voltage conductor-conductor Rated impulse voltage Pollution degree Rated voltage accd. to UL/CSA 600 V</p> | <p>10 20 004 0001</p> |  <p>Assembly cut out bulkhead mounted housing 22 x 22 mm</p>  |
| <p>Han-Kit®-4AWM</p> <p>Hood Han® 3 A straight Bulkhead mounted hous.¹⁾ Han® 3 A angled Material Die cast zinc alloy Protection degree²⁾ IP 67 Cable gland M20, metal Cable diameter 5 - 9 mm / 6 - 12 mm Insert Han® 4 A, 4-pins + PE Screw terminal 1-2.5 mm², AWG 18-14 Electrical data accd. to DIN EN 61 984³⁾ 10 A 230/400 V 4kV 3</p>  <p>Rated current Rated voltage conductor-ground Rated voltage conductor-conductor Rated impulse voltage Pollution degree Rated voltage accd. to UL/CSA 600 V</p> | <p>10 20 004 0003</p> |  <p>Assembly cut out bulkhead mounted housing 22 x 22 mm</p>  |
| <p>Han-Kit®-4AWSM</p> <p>Hood Han® 3 A angled Bulkhead mounted hous.¹⁾ Han® 3 A straight Material Die cast zinc alloy Protection degree²⁾ IP 67 Cable gland M20, metal Cable diameter 5 - 9 mm / 6 - 12 mm Insert Han® 4 A, 4-pins + PE Screw terminal 1-2.5 mm², AWG 18-14 Electrical data accd. to DIN EN 61 984³⁾ 10 A 230/400 V 4kV 3</p>  <p>Rated current Rated voltage conductor-ground Rated voltage conductor-conductor Rated impulse voltage Pollution degree Rated voltage accd. to UL/CSA 600 V</p> | <p>10 20 004 0005</p> <p>1) Bulkhead mounted housing with flange gasket 2) Protection degree accd. to DIN EN 60 529 in locked position 3) For only use in grounded circuits</p> |  <p>Assembly cut out bulkhead mounted housing 22 x 22 mm</p>  |

Han® 4 A Plastic Version

Part-Number

Dimensions in mm

Han-Kit®-4AGK

| | |
|--|-----------------------------------|
| Hood | Han® 3 A straight |
| Bulkhead mounted hous. ¹⁾ | Han® 3 A straight |
| Material | Plastic |
| Protection degree ²⁾ | IP 67 |
| Cable gland | M20, plastic |
| Cable diameter | 5 - 9 mm / 6 - 12 mm |
| Insert | Han® 4 A, 4-pins + PE |
| Screw terminal | 1-2.5 mm ² , AWG 18-14 |
| Electrical data accd. to DIN EN 61 984 ³⁾ | 10 A 230/400 V 4kV 3 |
| Rated current | |
| Rated voltage conductor-ground | |
| Rated voltage conductor-conductor | |
| Rated impulse voltage | |
| Pollution degree | |
| Rated voltage accd. to UL/CSA | 600 V |

10 20 004 0002



Assembly cut out bulkhead mounted housing 22 x 22 mm

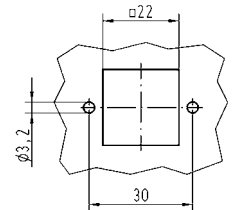

Han-Kit®-4AWK

| | |
|--|-----------------------------------|
| Hood | Han® 3 A straight |
| Bulkhead mounted hous. ¹⁾ | Han® 3 A angled |
| Material | Plastic |
| Protection degree ²⁾ | IP 67 |
| Cable gland | M20, plastic |
| Cable diameter | 5 - 9 mm / 6 - 12 mm |
| Insert | Han® 4 A, 4-pins + PE |
| Screw terminal | 1-2.5 mm ² , AWG 18-14 |
| Electrical data accd. to DIN EN 61 984 ³⁾ | 10 A 230/400 V 4kV 3 |
| Rated current | |
| Rated voltage conductor-ground | |
| Rated voltage conductor-conductor | |
| Rated impulse voltage | |
| Pollution degree | |
| Rated voltage accd. to UL/CSA | 600 V |

10 20 004 0004



Assembly cut out bulkhead mounted housing 22 x 22 mm

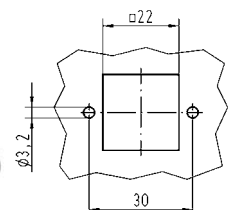

- 1) Bulkhead mounted housing with flange gasket
- 2) Protection degree accd. to DIN EN 60 529 in locked position
- 3) For only use in grounded circuits

Han® 10 A

Part-Number

Dimensions in mm

Han-Kit®-10A

Hood¹⁾ Han® 10 A
 Material Die cast aluminium alloy
 Protection degree²⁾ IP 65
 Cable gland M20, metal
 Cable diameter 5 - 9 mm / 6 - 12 mm

Insert Han® 10 A, 10-pins + PE
 Screw terminal 1-2.5 mm², AWG 18-14

Electrical data accd. to DIN EN 61 984³⁾
16 A 250 V 4kV 3

Rated current
 Rated voltage³⁾
 Rated impulse voltage
 Pollution degree

Rated voltage
 accd. to UL/CSA 600 V

10 20 010 0000



Assembly cut out
 bulkhead mounted
 housing
 57 x 24 mm

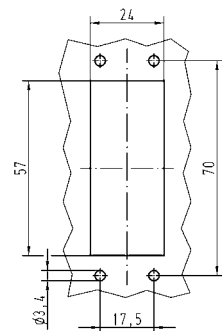

Han® 16 A

Part-Number

Dimensions in mm

Han-Kit®-16A

Hood¹⁾ Han® 16 A
 Material Die cast aluminium alloy
 Protection degree²⁾ IP 65
 Cable gland M20, metal
 Cable diameter 5 - 9 mm / 6 - 12 mm

Insert Han® 16 A, 16-pins + PE
 Screw terminal 1-2.5 mm², AWG 18-14

Electrical data accd. to DIN EN 61 984³⁾
16 A 250 V 4kV 3

Rated current
 Rated voltage³⁾
 Rated impulse voltage
 Pollution degree

Rated voltage
 accd. to UL/CSA 600 V

10 20 016 0000



Assembly cut out
 bulkhead mounted
 housing
 73 x 24 mm

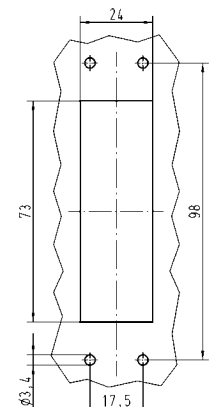

1) Bulkhead mounted housing with flange gasket
 2) Protection degree accd. to DIN EN 60 529 in locked position
 3) For use in a un-grounded circuit or a grounded delta circuit

Han® 6 B

Part-Number

Dimensions in mm

Han-Kit®-6B

Hood¹⁾ Han® 6 B
 Material Die cast aluminium alloy
 Protection degree²⁾ IP 65
 Cable gland M20, metal
 Cable diameter 5 - 9 mm / 6 - 12 mm

Insert Han® 6 E, 6-pins + PE
 Screw terminal 1-2.5 mm², AWG 18-14

Electrical data accd. to DIN EN 61 984³⁾

16 A 500 V 6kV 3

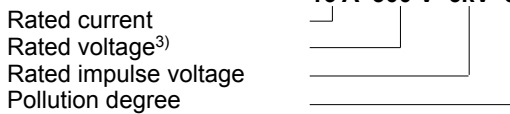

Rated voltage accd. to UL/CSA 600 V

10 33 006 0000



| Dimensions in mm | Han-Kit 6 B |
|---|-------------|
| a | 48 |
| b | 70 |
| Assembly cut out bulkhead mounted housing | 48x35 |

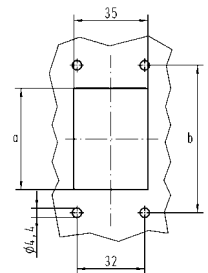

Han® 10 B

Part-Number

Dimensions in mm

Han-Kit®-10B

Hood¹⁾ Han® 10 B
 Material Die cast aluminium alloy
 Protection degree²⁾ IP 65
 Cable gland M25, metal
 Cable diameter 9 - 16 mm / 13 - 18 mm

Insert Han® 10 E, 10-pins + PE
 Screw terminal 1-2.5 mm², AWG 18-14

Electrical data accd. to DIN EN 61 984³⁾

16 A 500 V 6kV 3

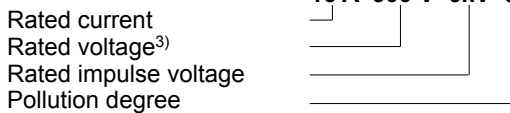

Rated voltage accd. to UL/CSA 600 V

10 33 010 0000



| Dimensions in mm | Han-Kit 10 B |
|---|--------------|
| a | 60 |
| b | 83 |
| Assembly cut out bulkhead mounted housing | 60 x 35 |

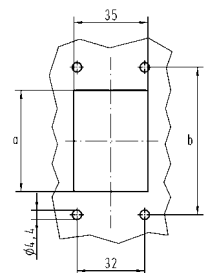

1) Bulkhead mounted housing with flange gasket
 2) Protection degree accd. to DIN EN 60 529 in locked position
 3) For use in a un-grounded circuit or a grounded delta circuit

Han® 16 B

Part-Number

Dimensions in mm

Han-Kit®-16B

Hood¹⁾ Han® 16 B
 Material Die cast aluminium alloy
 Protection degree²⁾ IP 65
 Cable gland M32, metal
 Cable diameter 13-20 mm / 18-25 mm

Insert Han® 16 E, 16-pins + PE
 Screw terminal 1-2.5 mm², AWG 18-14

Electrical data accd. to DIN EN 61 984³⁾

16 A 500 V 6kV 3

Rated current
 Rated voltage³⁾
 Rated impulse voltage
 Pollution degree

Rated voltage
 accd. to UL/CSA 600 V

10 33 016 0000



| Dimensions in mm | Han-Kit 16 B |
|---|--------------|
| a | 82 |
| b | 103 |
| Assembly cut out bulkhead mounted housing | 82 x 35 |

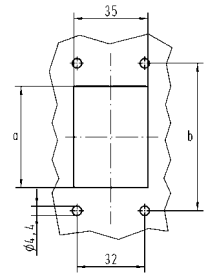

Han® 24 B

Part-Number

Dimensions in mm

Han-Kit®-24B

Hood¹⁾ Han® 24 B
 Material Die cast aluminium alloy
 Protection degree²⁾ IP 65
 Cable gland M32, metal
 Cable diameter 13-20 mm / 18-25 mm

Insert Han® 24 E, 24-pins + PE
 Screw terminal 1-2.5 mm², AWG 18-14

Electrical data accd. to DIN EN 61 984³⁾

16 A 500 V 6kV 3

Rated current
 Rated voltage³⁾
 Rated impulse voltage
 Pollution degree

Rated voltage
 accd. to UL/CSA 600 V

10 33 024 0000



| Dimensions in mm | Han-Kit 24 B |
|---|--------------|
| a | 108 |
| b | 130 |
| Assembly cut out bulkhead mounted housing | 108x35 |

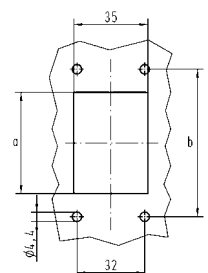

1) Bulkhead mounted housing with flange gasket
 2) Protection degree accd. to DIN EN 60 529 in locked position
 3) For use in a un-grounded circuit or a grounded delta circuit

Product Range



Industrial Connectors Han®



Network components for industrial communication



Components for energy distribution Han-Power® and Han-Compact®



Circular Connectors HARAX® and overmoulded variants for automation



Fiber optic data link systems and components



Components for cabinets and boxes Han-Snap® and Han-Port®

Subsidiary companies – worldwide



Sales partner – worldwide



Austria: HARTING Ges. m. b. H.
Deutschstraße 19, A-1230 Wien
Phone +431/6162121, Fax +431/6162121-21
E-Mail: at@HARTING.com

Belgium: HARTING N.V./S.A.
Z.3 Doornveld 23, B-1731 Zellik
Phone +322/4660190, Fax +322/4667855
E-Mail: be@HARTING.com

Brazil: HARTING Ltda.
Av. Dr. Lino de Moraes, Pq. Jabaquara, 255
CEP 04360-001 - São Paulo - SP - Brazil
Phone +5511/5035-0073, Fax +5511/5034-4743
E-Mail: br@HARTING.com, Internet: www.HARTING.com.br

China: Zhuhai HARTING, Limited Shanghai Branch
Room 5403, 300 Huaihai Zhong Road
Hong Kong New World Tower, Luwan District, P.R.C
Shanghai 200021, China
Phone +86 21 - 63 86 22 00, Fax +86 21 - 63 86 86 36
E-Mail: cn@HARTING.com

Czech Republic: HARTING spol. s.r.o.,
Mlýnská 2, 16000 Praha 6
Phone +420 220 380 460, Fax +420 220 380 461
E-Mail: cz@HARTING.com, Internet: www.HARTING.cz

Eastern-Europe: HARTING Eastern Europe GmbH
Bamberger Straße 7, D-01187 Dresden
Phone +49 351 / 4361760, Fax +49 351 / 4361770
E-Mail: Eastern.Europe@HARTING.com

Finland: HARTING Oy
Hakamäenkuja 11 A, FIN-01510 Vantaa
Phone +358 9 350 873 00, Fax +358 9 350 873 20
E-Mail: fi@HARTING.com

France: HARTING France
181 avenue des Nations, Paris Nord 2
BP 66058 Tremblay en France
F-95972 Roissy Charles de Gaulle Cédex
Phone +33149383400, Fax +33148632306
E-Mail: fr@HARTING.com

Germany: HARTING Deutschland GmbH & Co. KG
Postfach 2451 · D-32381 Minden
Simeons carré 1 · D-32427 Minden
Phone (0571) 8896-0, Fax (0571) 8896-282
E-Mail: de@HARTING.com, Internet: www.HARTING.com

Office Germany: HARTING Deutschland GmbH & Co. KG
Blankenauer Straße 99, D-09113 Chemnitz
Phone +49 0371 429211, Fax +49 0371 429222
E-Mail: de@HARTING.com

Great Britain: HARTING Ltd.
Caswell Road, Brackmills Industrial Estate
GB-Northampton, NN4 7PW
Phone +441604/766686, 827500, Fax +441604/706777,
E-Mail: gb@HARTING.com, Internet: www.HARTING.co.uk

Hong Kong: HARTING (HK) Ltd.
Regional Office Asia Pacific
4208 Metroplaza Tower 1, 223 Hing Fong Road
Kwai Fong, N. T., Hong Kong
Phone +852/2423-7338, Fax +852/2480-4378
E-Mail: ap@HARTING.com
Internet: www.HARTING.com.hk

Hungary: HARTING Magyarország Kft.
Fehérvári út 89-95, H1119 Budapest
Phone +36-1-205 3464, Fax +36-1-205 3465
E-Mail: hu@HARTING.com, Internet: www.HARTING.hu

India: HARTING India Private Limited
No. D, 4th Floor, 'Doshi Towers'
No. 156 Poonamallee High Rd,
Kilpauk, Chennai 600 010, Tamil Nadu, Chennai, INDIA
Phone +91-44-4356 0415/6, Fax +91-44-4356 0417
E-Mail: in@HARTING.com, Internet: www.HARTING.com

Italy: HARTING SpA
Via Dell' Industria 7, I-20090 Vimodrone (Milano)
Phone +3902/250801, Fax +3902/2650597
E-Mail: it@HARTING.com

Japan: HARTING K. K.
Yusen Shin-Yokohama 1 Chome Bldg., 2F
1-7-9, Shin-Yokohama
Kohoku-ku, Yokohama, 222-0033 Japan
Phone +81 45 476 3456, Fax +81 45 476 3466
E-Mail: jp@HARTING.com, Internet: www.HARTING.co.jp

Korea: HARTING Korea Limited
#308 Leaders Bldg., 342-1, Yatap-dong, Bundang-gu,
Sungnam-City, Kyunggi-do, 463-828, Korea
Phone +82-31-781-4615, Fax +82-31-781-4616
E-Mail: kr@HARTING.com

Netherlands: HARTING B.V.
Larenweg 44, NL-5234 KA 's-Hertogenbosch
Phone +3173/6410404, Fax +3173/6440699
E-Mail: nl@HARTING.com

Norway: HARTING A/S,
Østensjøveien 36, N-0667 Oslo,
Phone +4722/700555, Fax +4722/700570
E-Mail: no@HARTING.com

Poland: HARTING Polska Sp. z o.o.
ul. Kamieńskiego 201-219, 51-126 Wrocław
Phone +48 71-352 81 71/74, Fax +48 71-320 74 44
E-Mail: pl@HARTING.com, Internet: www.HARTING.pl

Portugal: HARTING Iberia, S. A.
Avda. Josep Tarradellas 20-30, 4º 6º, E-08029 Barcelona
Phone +351.219.673.177, Fax +351.219.678.457
E-Mail: es@HARTING.com

Russia: HARTING ZAO
ul. Tobolskaja 12, Saint Petersburg, 194044 Russia
Phone +7812/3276477, Fax +7812/3276478
E-Mail: ru@HARTING.com, Internet: www.HARTING.ru

Singapore: HARTING Singapore Pte Ltd.
No. 1 Coleman Street, #B1-21 The Adelphi
Singapore 179803
Phone +6562255285, Fax +6562259947
E-Mail: sg@HARTING.com

Spain: HARTING Iberia S.A.
Josep Tarradellas 20-30 4º 6º, E-08029 Barcelona
Phone +34 933 638 475, Fax +34 934 199 585
E-Mail: es@HARTING.com

Sweden: HARTING AB
Gustavslundsvägen 141 B 4tr, 167 51 Bromma
Phone +468/4457171, Fax +468/4457170
E-Mail: se@HARTING.com

Switzerland: HARTING AG
Industriestrasse 26, CH-8604 Volketswil
Phone +41 44 908 20 60, Fax +41 44 908 20 69
E-Mail: ch@HARTING.com

Taiwan: HARTING R.O.C. Limited
Rm 1, 5th Floor, No. 495, GuangFu-South-Rd,
Taipei, 110 Taiwan
Tel. +886-2-2758-6177, Fax +886-2-2758-7177
E-Mail: tw@HARTING.com
Internet: www.HARTING.com.tw

USA: HARTING Inc. of North America
1370 Bowes Road, Elgin, Illinois 60123
Phone +1 (877) 741-1500 (toll free)
Fax +1 (866) 278-0307 (Inside Sales)
Fax +1 (847) 717-9430 (Sales and Marketing)
E-Mail: us@HARTING.com
Internet: www.HARTING-USA.com

Other countries:
Please contact your Global Business Unit

Argentina: Condel Electronica
Julian Agüero 3355
(1605) Munro - Pcia. de Buenos Aires
Phone + Fax +54 11 4762.0118
E-Mail: mediavicondel@arnet.com.ar

Denmark: Knud Wexøe A/S
Skaettekaeret 11, P.O. Box 152
Phone +359-2-9155800, Fax +359-2-9540384
office@comet.bg; www.comet.bg

Estland: SKS Tehnika OÜ
Liimi 1, EE-10621 Tallinn
Tel. +372 699 0171, Fax +372 699 0170
E-Mail: tehnika@sk.fi, Internet: www.sk.fi

Finland: SKS Automaatio OY
Martinkyläntie 50, FIN-01720 Vantaa
Phone +358 20 76461, Fax +35 20 7646820
E-Mail: automaatio@sk.fi, Internet: www.sk.fi

Island: Smith & Norland
Nóatún 4; IS-105 Reykjavík
Phone +354 520 3000, Fax +354 520 3011
olaf@smn.in.is; www.sminor.is

Israel: MIGVAN Technologies & Engineering Ltd.
13 Hashiloh St., P.O.Box 7022
IL - Petach Tikva 49170
Phone +972 3 9240784, Fax +972 3 9240787
info@mte.co.il, www.mte.co.il

South-Africa: HellermannTyton Pty Ltd.
Private Bag X158 Rivonia 2128
34 Milky Way Avenue
Linbro Business Park 2065
Johannesburg, South Africa
Phone +27 (0)11 879-6600
Fax +27 (0)11 879-6606
E-Mail: sales.jhb@hellermann.co.za

Turkey: Gökhan Elektrik San. Tic. Ltd. Sti.
Perpa Elektrikçiler Is Merkezi A Blok
Kat:7-8-9 No.694
TR - 80270 Okmeydanı/Istanbul
Phone +90 (212) 2 21 32 36 (pbx)
Fax +90 (212) 2 21 32 40
E-Mail: gokhan@gokhanelektrik.com

Ukraine: Incomtech Ltd.
4 Lermontovskaya St., UA-04050 Kiev
Phone +380-44-213-3641, Fax +380-44-213-3814
E-Mail: eletech@incomtech.com.ua
Internet: www.incomtech.com.ua

Global Business Unit Electric



HARTING Electric GmbH & Co. KG
P.O. Box 1473
D-32328 Espelkamp
Phone +49 57 72 / 47-97 100
Fax +49 57 72 / 47-49 5
E-Mail: electric@HARTING.com
Internet: www.HARTING.com

Your Contact Partner

